

**UNIVERSIDAD EAFIT**

Engineering School  
Design Engineering Research Group (GRID)



**Information management method based on a Knowledge  
Management (KM) approach for Human Supervisory  
Control Systems**

GRADUATION MANUSCRIPT PRESENTED AS PARTIAL REQUIREMENT TO OBTAIN THE  
**MASTER OF SCIENCE IN ENGINEERING**  
*(Draft Document: Version 15/06/2017)*

AUTHOR:

**Ing. Mauricio Fernández-Montoya**

ADVISOR:

**Ricardo Mejía-Gutiérrez, PhD.**

June 2017





# Abstract

With the increasing level of technological developments, technical systems have become more and more complex. This complexity allows systems to perform a greater number of tasks in a more efficient and fast way. These tasks enable the system to achieve an objective that can be related to, either the materialization of a product, the provision of a service or the satisfactory execution of a mission. These Complex Systems (CS), can be an industrial plant or process, as well as aerospace systems, energy facilities, military industry, civil industry, aircraft, transportation, sports, etc. They all have in common, that a great amount of tasks may be automated, but anyway, they need human supervision through the so-called “Operators” (who are the qualified personnel in charge of maintaining the stability of the process). This operators must perform a constant monitoring and control, mainly through Human Machine Interfaces (HMI) and this Human-Machine interaction is studied by the field of Human Supervised Control (HSC). As CS have become more critical, they require the monitoring of more subsystems and variables, making them more susceptible to failures due to errors of the human operators. From the literature study, it is evident that in order to avoid such errors, three aspects become relevant: i) the level of automation of the processes have a direct influence on the flow of information between the CS and the Operators, ii) the ergonomics of the graphical interfaces its critical to facilitate the interpretation of that information and iii) methodologies for a systematic CS design become necessary to guarantee tasks accomplishment. These aspects become more critical, because CS generally integrates heterogeneous subsystems and components, which increases considerably the amount of information available to operators. The problem is that Operators, who are experts in their disciplines, use a preferred set of data, linked to their particular knowledge (without considering the full set of variables of the whole system), to perform monitoring and control tasks. It was also found in the literature that CS designers do not have a clear or formal guideline for selection and weighting of the relevant data. Consequently, this project proposes an information management method based on a Knowledge Management (KM), to select and weight mission data in Human Supervision Control Systems (HSC). The method is based on the functional analysis of the process, as well as the generation of functions from its main objective. This method was applied in a case study, where an analysis was performed around a mission control of a solar vehicle, that compete in the *Bridgestone World Solar Challenge 2015*. It was found that the number of relevant variables to monitor the competition was small, compared to the big set of available variables. Another finding, was that the set of relevant variables is strongly influenced by the Operating States (OS) of the vehicle throughout the different moments of the competition. Although there are some variables that are consistently stronger than others in all OS, in general, the variables’ importance presents a variable behavior between OS, concluding that the relevance of the variables is dynamic.

**Keywords:** human supervisory control, mission control, Variable Weighting, Process, operators

## Resumen

Con el incremento en el nivel de los desarrollos tecnológicos, los sistemas técnicos se han vuelto más y más complejos. Esta complejidad le permite a los sistemas ejecutar una cantidad mayor de tareas de forma más eficiente y rápida. Estas tareas le permiten al sistema alcanzar un objetivo que puede relacionarse, sea con la materialización de un producto, la prestación de un servicio, o la ejecución satisfactoria de una misión. Estos Sistemas Complejos (SC), puede ser una planta industrial o un proceso, así como los sistemas aeroespaciales, instalaciones de energía, industrial militar, industria civil, aeronaves, transporte, deportes, etc. Todas estas tienen en común, que aunque muchas de las tareas se pueden automatizar, requieren de supervisión humana a través de los llamados "Operadores" (quienes son personal calificado encargados de mantener la estabilidad del proceso). Estos Operadores deben realiza un monitoreo y control constantes, principalmente a través de Interfaces Humano-Maquina (IHM) y esta interacción es estudiada por el campo del Control Supervisado por Humanos (CSH). A medida que los SC se vuelven más críticos, requieren el monitoreo de más subsistemas y variables, haciendolos más susceptibles a fallas debido a errores de los operadores humanos. Del estudio de literatura, es evidente que con el fin de evitar estos errores, tres aspectos se vuelven relevantes: i) El nivel de automatización de los procesos tiene una influencia directa en el flujo de información entre el SC y los Operadores, ii) La ergonomía de las interfaces gráficas es crítica para facilitar la interpretación de la inforación y iii) Metodologías para el diseño sistemático de los SC se vuelven necesarios para garantizar el cumplimiento de las tareas. Estos aspectos se vuelven más críticos, porque los SC generalmente integran sistemas y componentes heterogeneos, los cuales incrementan considerablemente la cantidad de información disponible para los operadores. El problema es que, los Operadores, quienes son expertos en sus disciplinas, utilizan un conjunto de datos preferidos, que está vinculado con su conocimiento particular (sin considerar el conjunto total de variables de todo el sistema), para realizar las tareas de monitoreo y control. Se encontró también en la literatura, que los diseñadores de los SC no tienen lineamientos formales o claros de la selección y ponderación de los datos relevantes. Consecuentemente, este proyecto propone un método basado en Knowledge Managment (KM) para seleccionar y ponderar datos de misión en Sistemas de Control Supervisado por Humanos (HSC). El método se basa en el análisis funcional del proceso, así como la generación de funciones a partir del objetivo principal de misión. Este método fue aplicado en un caso de estudio, donde se realizó el análisis alrededor del control de misión de un vehículo solar, que compitió en el *Bridgestone World Solar Challenge 2015*. Se encontró que el número de variables relevantes para monitorear la carrera fue pequeña, comparada con el gran conjunto de variables disponibles. Otro hallazgo, fue que el conjunto de variables relevantes está fuertemente influenciado por los Estados Operativos (EO) del vehículo a través de los distintos momentos de la competencia. Aunque algunas de las variables que son consistentemente más fuertes que otras en todos los EO, en general, la importancia de las variables presenta un comportamiento variable entre EO, concluyendo que la relevancia de las variables es dinámica.

**Palabras Clave:** Control Supervisado por Humanos, control de misión, ponderación de variables, proceso, operadores

## **Personal publications**

During the development of this research project, some of the results were submitted to international peer review processes and published. These articles were published in:

Journal:

- International Journal of Energy Research (IJoER). John Wiley & Sons Ltd, United Kingdom.  
ISSN: 0363907X.

Conferences:

- 3rd International Conference on Mechanical, Materials and Manufacturing, (ICMMM'2016), Savannah, GA.



# Acknowledgements

Agradezco a Ruth, Mi madre. A mis hermanos Virginia, Sebastián y Manuela, de quienes recibí su apoyo incondicional durante la realización del proyecto, sobretodo en los momentos más difíciles. Extiendo el agradecimiento a mi Asesor Ricardo Mejía y a Gilberto Osorio, quienes supieron direccionar adecuadamente los objetivos del proyecto y de quienes recibí también un gran apoyo, no solo desde la academia sino a nivel personal.

A *Empresas Públicas de Medellín* y a la *Universidad EAFIT*, quienes desde 2012 creyeron en mis capacidades y me permitieron participar en el proyecto del Vehículo Solar, Proyecto de Ingeniería destacado en Colombia, Orgullo de Antioquia y Primero en su tipo en el país. Además de los aprendizajes en tecnologías que son emergentes en Colombia, y de las gratas experiencias vividas durante las dos competencias en Suelo Australiano, el proyecto me permitió tener una mirada más crítica a mi entorno desde la Ingeniería, y me enseñó a apostarle al desarrollo de tecnologías limpias en el país.

A todos, Mil y Mil GRACIAS;



# Contents

<b>1</b>	<b>Introduction</b>	<b>1</b>
1.1	Background: Control Rooms and Human Supervisory Control . . . . .	1
1.2	Research question . . . . .	9
1.3	Project Objectives . . . . .	9
1.3.1	General objective . . . . .	9
1.3.2	Specific objectives . . . . .	9
1.4	Research Scope . . . . .	9
1.5	Research Approach - Design Inclusive Research (DIR) . . . . .	10
<b>2</b>	<b>State of the Art</b>	<b>13</b>
2.1	Human Supervisory Control . . . . .	14
2.1.1	Contribution of Space Program to Human Supervisory Control Systems . . . . .	15
2.1.2	Industrial applications: Virtual Process Visualization Concept (VPVC) . . . . .	22
2.1.3	Automotive Applications - Solar Electric Vehicles . . . . .	23
2.1.4	Ecological Design of Interfaces (EID) . . . . .	25
2.1.5	Maintenance over time . . . . .	27
2.2	Knowledge Management (KM) Approach . . . . .	28
2.2.1	Knowledge management (KM) in the organizational field. . . . .	29
2.2.2	Knowledge Management in Decision Making . . . . .	30
2.2.3	The quantity of information vs the quality of information. . . . .	31
2.2.4	Knowledge Management Tools . . . . .	32
2.3	Discussion of Previous Approaches . . . . .	33

<b>3</b>	<b>Function to Data Matrix (FDM) applied to Mission Control Rooms - Human Supervisory Systems</b>	<b>37</b>
3.1	Step 1: Mission/Process Essential Analysis . . . . .	40
3.1.1	Mission/Process Work Statement . . . . .	41
3.1.2	Mission/Process Description . . . . .	41
3.2	Step 2: Basic Functions Analysis . . . . .	42
3.2.1	Goal to Function Tree GFT . . . . .	43
3.2.2	Prüfer Sequence for Goal to Function Tree . . . . .	44
3.2.3	Basic Function weighing . . . . .	47
3.3	Step 3: Operative Stages Analysis . . . . .	48
3.4	Step 4: Functional Structure Analysis . . . . .	51
3.4.1	System Functional Structure . . . . .	51
3.4.2	Addition of Sensors . . . . .	53
3.4.3	Variable Attributes . . . . .	55
3.5	Step 5: Function to Data Matrix . . . . .	58
3.5.1	Function to Data Matrix . . . . .	59
3.5.2	Experts Score . . . . .	60
3.5.3	Variable Relevance Indicator Threshold . . . . .	63
<b>4</b>	<b>Case Study: Solar Electric Vehicle (SEV) Racing</b>	<b>65</b>
4.1	Racing Electric Solar Vehicles . . . . .	65
4.1.1	World Solar Challenge . . . . .	67
4.1.2	Vehicle Design and Optimization . . . . .	68
4.2	Case Study: Racing Solar Electric Vehicle <i>Primavera2</i> . . . . .	69
4.2.1	Step 1: Mission/Process Essential Analysis . . . . .	72
4.2.2	Step 2: Basic Functions Analysis . . . . .	79
4.2.3	Step 3: Operative Stages Analysis . . . . .	85
4.2.4	Step 4: Functional Structure Analysis . . . . .	88
4.2.5	Step 5: Function to Data Matrix . . . . .	94
4.2.6	Variable Relevance Indicator Threshold . . . . .	97

---

<b>5 Conclusions</b>	<b>105</b>
5.0.7 Recommendations and Further research . . . . .	107
<b>References</b>	<b>109</b>
<b>Appendix A Space Mission Analysis and Design - SMAD Example: <i>FireSat</i></b>	<b>117</b>
<b>Appendix B Bridgestone World Solar Challenge 2015 Regulations</b>	<b>121</b>
<b>Appendix C Function to Data Matrix Analysis for Primavera 2 Solar Car - Bridgestone World Solar Challenge 2015</b>	<b>127</b>
<b>Appendix D Specific Power Consumption SPC Graphic for <i>Primavera 2</i> for Bridgestone World Solar Challenge 2017</b>	<b>141</b>



# List of Figures

1.1	Dr. Wernher von Braun, the NASA Director of the Marshall Space Flight Center, and President John F. Kennedy at Cape Canaveral, Florida on November 16, 1963.[John F. Kennedy Presidential Library and Museum, 2017] . . . . .	3
1.2	NEAR Mission Operations Center [Baer et al., 1999]. . . . .	5
1.3	Larry Perkins steering the Quiet Achiever, the first Operational Solar Vehicle [Snooks, 2015] . . . . .	6
1.4	Design Inclusive Research Methodology major phases [Imre, 2007] . . . . .	10
2.1	Human Supervisory Control simplified scheme.[Sheridan, 1992] . . . . .	15
2.2	Caricature of (a) completely automated, and (b) manually controlled Apollo Command Module [Sim et al., 2008]. . . . .	16
2.3	NASA Human Factors Engineering process [Shishko and Aster, 1995] . . . . .	18
2.4	Primary screen of the Space Shuttle propulsion subsystems [Horvitz and Barry, 1995].	20
2.5	Primary screen of the Space Shuttle propulsion subsystems Showing expanded OMS from the screen manager [Horvitz and Barry, 1995]. . . . .	21
2.6	Process Overview designed by VPVC Concept 2.6(a). Standard Topological Interface 2.6(b). [Wittenberg, 2004] . . . . .	23
2.7	GUI designed for University of Missouri-Rolla Solar Vehicle in 1999 [McCarthy et al., 2000]. . . . .	25
2.8	Work domain boundaries proposed for a Solar Vehicle[Hilliard and Jamieson, 2007].	26
2.9	Energy GUI Prototype for BluSky Solar Vehicle [Hilliard and Jamieson, 2008]. . . .	27
2.10	Powerflow tab of the Solar Vehicle from TUDelft [Van Baar et al., 2014]. . . . .	29
2.11	Decision Making Process activities in an Organization [Zoltayné Paprika, 2001]. . .	31

3.1	Simplified scheme of Function to Data Matrix (FDM) approach applied to Mission Control Rooms . . . . .	38
3.2	Complete scheme of Function to Data Matrix (FDM) approach applied to MC rooms . . . . .	39
3.3	Goal to function tree Graph . . . . .	44
3.4	Function to Data Matrix construction from a mission statement analysis . . . . .	45
3.5	Algorithm to convert a Prüfer sequence into a tree[Chair of Combinatory Geometry, 2016] . . . . .	46
3.6	Operational stages general series-parallel tasks scheme . . . . .	49
3.7	FD structure, with incoming and outgoing flows of energy, matter and signal [Pahl and Beitz, 2013] . . . . .	52
3.8	Theoretical function carrier block definition for a sensor . . . . .	53
3.9	Theoretical Sensor Addition in a Functional structure. . . . .	54
3.10	Graphic definition of Acceptable Operative Interval (AOI) and Safe Design Interval (SDI) for a process variable . . . . .	57
3.11	Membresy Function defined for a Mission Variable . . . . .	57
3.12	FDM evolution due to changing operative stages . . . . .	63
4.1	Solar Electric Vehicle Simplified scheme [Science Learningn Hub - The University of Waikato, 2010] . . . . .	66
4.2	Bridgestone World Solar Challenge 2015 Roadmap [South Australian Tourism Commission - The Motor Sport Group., 2017] . . . . .	67
4.3	Primavera 2 Solar Vehicle Cruising in Stuart Highway and charging process during 30 minute mandatory control-stop . . . . .	68
4.4	Primavera 2 Solar Vehicle tests in Aeroparque Juan Pablo II Racetrack in Medellín . . . . .	70
4.5	Primavera 2 Convoy scheme for World Solar Challenge 2015 competition . . . . .	75
4.6	<i>Primavera2</i> Control Stop Activities. . . . .	77
4.7	GFT for a WSC 2015 race and Challenger Class Vehicle . . . . .	83
4.8	Photos for OS of <i>Primavera 2</i> during World Solar Challenge 2015 for $OS_1$ 4.8(a), for $OS_2$ 4.8(b), for $OS_3$ 4.8(c) and $OS_4$ 4.8(d) . . . . .	89
4.9	Simplified FD of <i>Primavera 2</i> based on the analysis of its subsystems. . . . .	91
4.10	Sensor addition criteria for <i>Primavera 2</i> . . . . .	92

4.11	Current, voltage and temperature CAN node for <i>Primavera 2</i> Solar array and battery pack. . . . .	93
4.12	Summary of FDM for <i>Primavera 2</i> . Selected Information across basic functions were obtained from GFT presented in Fig.4.7 . . . . .	95
4.13	VRI value tendency for $OS_1$ 4.13(a), for $OS_2$ 4.13(b), for $OS_3$ 4.13(c) and $OS_4$ 4.13(d)	96
4.14	VRI Tendency lines comparative for $OS_2, OS_3$ and $OS_4$ . . . . .	97
4.15	VRI Values for variable selection after applying a threshold adjustment value of $K_{Th} = 0.7$ . . . . .	99
4.16	VRI Values for variable selection after applying a threshold adjustment value of $K_{Th} = 0.7$ . Threshold effect on the complete set of variables 4.16(a). Threshold effect on the final set of variables. 4.16(b) . . . . .	100
4.17	<i>Primavera2</i> Qt-based proposed GUI design for <i>Bridgestone World Solar Challenge 2015</i> race . . . . .	102
A.1	Space Mission Architecture for Operator Requirements, end User Requirements and Developer Requirements for <i>FireSat</i> Study Case. Taken from [Larson and Wertz, 1992]	119
B.1	Mandatory rear vision areas for solar EV. Taken from [South Australian Tourism Commission - The Motor Sport Group., 2017] . . . . .	122
B.2	Tracking device specifications. Taken from [South Australian Tourism Commission - The Motor Sport Group., 2017] . . . . .	125
C.1	FDM Matrix for $OS_1$ of <i>Primavera2</i> Vehicle - World Solar Challenge 2015 . . . . .	128
C.2	FDM Matrix (continuation) for $OS_1$ of <i>Primavera2</i> Vehicle - World Solar Challenge 2015 . . . . .	129
C.3	FDM Matrix for $OS_2$ of <i>Primavera2</i> Vehicle - World Solar Challenge 2015 . . . . .	130
C.4	FDM Matrix (continuation) for $OS_2$ of <i>Primavera2</i> Vehicle - World Solar Challenge 2015 . . . . .	131
C.5	FDM Matrix for $OS_3$ of <i>Primavera2</i> Vehicle - World Solar Challenge 2015 . . . . .	132
C.6	FDM Matrix (continuation) for $OS_3$ of <i>Primavera2</i> Vehicle - World Solar Challenge 2015 . . . . .	133
C.7	FDM Matrix for $OS_4$ of <i>Primavera2</i> Vehicle - World Solar Challenge 2015 . . . . .	134

C.8	FDM Matrix (continuation) for $OS_4$ of <i>Primavera2</i> Vehicle - World Solar Challenge 2015 . . . . .	135
C.9	VRI values for <i>Primavera2</i> Vehicle - World Solar Challenge 2015 . . . . .	136
C.10	VRI values for <i>Primavera2</i> Vehicle - World Solar Challenge 2015 (Continuation) . .	137
C.11	VRI values for <i>Primavera2</i> Vehicle - World Solar Challenge 2015 (Continuation) . .	138
C.12	VRI values for <i>Primavera2</i> Vehicle - World Solar Challenge 2015 (Continuation) . .	139
D.1	Specific Power Consumption (SPC). added variable during <i>Primavera 2</i> race in Australia. . . . .	142

# List of Tables

3.1	Simplified Structure of Function to Data Matrix Analysis for HSC systems . . . . .	60
4.1	Top-Level Mission Requirements for <i>Bridgestone World Solar Challenge 2015</i> and <i>Primavera II</i> Solar Vehicle. . . . .	73
4.2	Operative Stage Matrix. Both vehicle Modes of Operation and Basic Functions for World Solar Challenge 2015 . . . . .	88
A.1	Examples of Top-Level Mission Requirements for <i>FireSat</i> Mission study case. We typically subdivide these top-level requirements into more specific requirements applicable to specific space missions.[Larson and Wertz, 1992] . . . . .	118



# Chapter 1

## Introduction

### 1.1 Background: Control Rooms and Human Supervisory Control

A control room is a place in where people called "Operators" controls a particular process (industrial process, aerospace device, racing vehicle, etc.), trying to minimize its unwanted variability. As the process has its own dynamic, it changes over time if "it is left alone". The interaction between Human Operators and the process is studied under Human Supervisory Control Systems (HSC). Operators controls energy or matter flows and their respective transformations into a final product, or sub-product, depending on the dynamics and purpose of the process. Generally, those systems can be defined as complex systems, which are composed of interacting simpler components, classified by their aggregation level [Perrow, 2011]:

1. Parts
2. Units
3. Subsystems
4. Systems

A process controlled by Operators, is accurately measured by precision monitoring devices, that ensures reliability, but increases complexity of the process itself [Wickens et al., 2015]. This complexity, and the fact that sometimes the controlled process is inaccessible to the operator (due to hazard risk, or in case where the process is far from the direct reach of Operators) and is handled artificially, most of the process inners and dynamics are not revealed, but, limited to data shown trough a screen.

Whereas the process is more isolated and physically separated to the control room, Operators become more displayed-data dependant, which implies the use of more sensors or instruments, trying

to improve operators panorama of how the process is behaving. But, as the amount of data increases, operators tasks become more difficult to develop as its workload increases [Woods et al., 1987].

As the process often is shown as a black box, only relevant information of certain parts and systems is shown to operators using Human Machine Interfaces (HMI), with limited data output and relying on sampling periods and propagation delays, slowing down data flow and response of the operators to unexpected behavior of the process [Wickens et al., 2015].

Complex process also must follow certain activities or stages with a particular sequence of activation and deactivation of specialized systems and their interactions. A proper achievement of particular tasks in every operational stage leads to completion of the main goals of the process. Recycling steel (for example), requires collecting raw material and scrap metal from different sources, then, it must be prepared and melt down in a furnace. After adding more material and homogenizing, molten material is spilled into a mould. If any stage is not completed, then the result will not be Steel ingots. If any step of the process doesn't comply with initial expectations or defined requirements, the entire operation will fail.

Same approach can be applied to a mission. Defined as *"Task that is assigned, imposed or self-imposed in order to achieve a goal"* and *"An important job, specially a military one, that someone is sent somewhere to do"* [Press, 2015], requires a logical combination of actions that leads objective compliance. Those actions can be performed, for instance, by people executing complex task and being supported by technological devices, or tools. Interactions between people and tools, shapes mission results.

A clear example of this definition can be found in the analysis of near space exploration missions performed by NASA. New Horizons, a recent space mission launched in 2006 claims that: *"The New Horizons mission is helping us understand worlds at the edge of our solar system by making the first reconnaissance of the dwarf planet Pluto and by venturing deeper into the distant, mysterious Kuiper Belt – a relic of solar system formation"* [NASA, 2016].

From last statement, mission goal is to build a device capable of leaving earth's atmosphere and reach Pluto surroundings. Then, this sort of device must "venture deeper" into Kuiper Belt. For leaving earth atmosphere a rocket and a probe must be designed, built, tested and operated. Every launch phase must be controlled (due to its variable dynamics) and monitored, to proceed with next phases.

Space exploration (since the 1960s) has popularized the term mission, alluding to the military roots of personnel in charge of aerospace operations. The launching into orbit of the sputnik in 1957 by the Soviet Union was a provocative and technological challenge for the post-war United States. Quickly, United States responded with the program Mercury, in the administration of the president Dwight D. Eisenhower. In 1961, a new provocation of the Soviets, orbiting the first human being, generated inquietude in the United States President, John F. Kennedy, (Fig.1.1) who urged Congress and the nation to "bring a person to the moon and Return it safely to the land before the end of the decade."



Figure 1.1: Dr. Wernher von Braun, the NASA Director of the Marshall Space Flight Center, and President John F. Kennedy at Cape Canaveral, Florida on November 16, 1963. [John F. Kennedy Presidential Library and Museum, 2017]

From the hand of the director of the *NASA Marshall Space Center*, Wernher Von Braun (who was the leading scientist in the development of the V2 rocket in the Nazi weapons program during World

War II), led the first Americans into orbit in the space, and by the end of the decade, 20 of July of 1969, put the first human beings in the lunar surface. The Kennedy challenge became the mission statement that was the most representative so far in terms of exploration. This statement was maintained for the entire *Apollo* program, which included certain technical capabilities in collection and handling of samples, scientific experimentation, and lunar exploration along 4 years, but all encompassed under the same objective [John F. Kennedy Presidential Library and Museum, 2017].

In a similar way it is done with a complex process like NASA Missions [NASA, 2016], a control room is needed. As the rocket is leaving Earth's atmosphere at high speeds, its engines are working at high pressures and extreme mechanical stresses, hostile and hazardous conditions for direct inspection or measurement by Operators, remote monitoring is also needed. Operators are highly displayed data-dependant and, latency and disorientation problems appears.

Therefore, a mission-oriented Control Room can be named as Mission Control Center or (MCC). MCC is a place where support activities for a particular operation or mission are performed [Encyclopedia, 2015], as shown in Fig. 1.2. In it, a group of people, usually called Mission Controllers (MC) or Operators are responsible for making decisions based on quantitative or qualitative information that comes from a measuring device or land, air or marine vehicle and whose objective is to complete a defined task (or mission). This MC ensures that operation tasks are conducted as planned as efficiently and safely as possible, ensuring compliance with the objectives of the mission [Aeronautics and Center, 2006].

Also called Mission Operations Center (MOC), is the home or place of the team responsible for planning and assessment of the spacecraft. Output commands to the spacecraft are piped to the tracking network or the data link to the vehicle flight systems. It serves as operations hub, and includes required tools for mission operations team or unmanned vehicle to conduct its operation. Typically, includes:

- Real-time Spacecraft monitoring/commanding system
- Flight system performance and status assessment systems
- Engineering Data Archive
- Flight simulators

Usually is the first telemetry raw data recipient and its routine, emergency and contingency activities are round-the-clock [Pisacane, 2005].



Figure 1.2: NEAR Mission Operations Center [Baer et al., 1999].

Although the MCC is commonly associated with the support ground team of space missions, such as the program *Apollo*, *Mars Pathfinder*, *Cassini-Huygens* [Sollazzo et al., 1995, Schilling, 1995], etc., a MCC can control operations ranging from air traffic control at airports to prototype aircraft [Impulse], monitoring submarine manned or unmanned devices, *formula 1* and race vehicles.

In this context, the MCC is responsible for receiving the vehicle performance information as raw data emerging from each functional subsystem through sensors or transmitters, and informing the pilot about necessary adjustments and driving behavior needed to win a race [Dictionary, 2015]. In general, received data is required to make decisions.

As the complexity of the vehicles increases, it is necessary to monitor a greater number of variables that allow it to run at a higher speed, with a better overall performance. As the resources used by the vehicle are limited (fuel capacity, tyre life, available Power or torque from the engine, etc.) it is necessary to monitor its performance thoroughly in order to take advantage of these resources to the maximum.

In races like the *Shell Eco-Marathon* in the United States, it is required that teams design competition vehicles that would be able to go as far as possible by spending the least amount of resources, whether fossil fuels, hydrogen or electricity stored in a battery, or from a photovoltaic panel [Global,

2015]. Other racing events as the *South Africa Solar Challenge*, *American Solar Challenge* and *World Solar Challenge* promotes the use of photovoltaic technology in high efficiency vehicles, restraining energy resources at its viable minimum.

*World Solar Challenge* is an international competition in which specialized electric vehicles must cover the distance between the cities of Darwin, in northern Australia, and Adelaide in the south (about 3,022 km) and only using solar energy [Watkins and Humphris, 2002].

The purpose of this race is to promote research through the use of alternative energy applied to electric mobility, whose development incentive practical applications. The competition was born from the initiative of Hans Tholstrup, who in 1982 traveled a distance of 4,130km between the cities of Perth and Sydney in a rudimentary electric vehicle with a solar panel, *The Quiet Achiever*, shown in Fig. 1.3. a low-power electric motor, a mechanical transmission, fiberglass body and bicycle wheels was used, reaching an average speed of 23km/h [Snooks, 2015]. 31 years later and although the rules of the race has reduced the size of both the solar panel and the battery, NUNA7, solar vehicle of the Technological University of Delft in the Netherlands, winner of the *World Solar Challenge 2013*, completed the race at an average speed of 90km/h [TUDelft, 2013].



Figure 1.3: Larry Perkins steering the Quiet Achiever, the first Operational Solar Vehicle [Snooks, 2015]

This increase in speed is due largely to technical advances in vehicle systems: Increased efficiency of the photovoltaic panel, weight reduction and improved energy battery capacity and refined

aerodynamic design. In addition, the constant measurement of the variables affecting the performance of the vehicle were sent, received and analyzed in real time by staff with specific expertise in vehicle subsystems, traveling in a convoy with the solar vehicle, in a similar way as MCC or MOC personnel does during a spaceflight operation. For this vehicles, it is desired to minimize power losses and maximize average vehicle speed to cross the finish line as fast as possible.

Although the solar vehicle is submitted to deterministic factors as weight distribution, aerodynamic design, wheel composition, track adjustments, motor efficiency, road GPS data, height profiles (all limited by designers criteria during design, manufacturing and commissioning stages) and probabilistic processes as wind conditions, temperature, solar radiation, road debris, death animals and other physical factors, etc. [Hilliard and Jamieson, 2008], only the vehicle speed can be controlled at any instant, so, the racing strategy should ensure no power wasting [Roche et al., 1997].

Consequently, based on requirements of a solar vehicle, the strategy must take into account:

- *"What is the best way to stop: Regenerative Braking, Friction Braking, or both?"*
- *What is the best tactic for passing under occasional broken clouds? How about several hours of predicted forecast?*
- *How do you alter your strategy for winds?*
- *What is the best way to descend or climb a hill?*
- *Given a 10 minutes stopping window after 5:00PM, what factors determine the optimum stopping location?*
- *How does competition status influence strategy decisions?"*[Roche et al., 1997]

So, Mission Controllers (often called Strategy Team) work is highly complex, monitoring large amounts of data that must be received, saved, integrated and processed[Hilliard and Jamieson, 2008]. As the vehicle is moving along large distances, strategy team escorts the vehicle in a second vehicle. Although there are limited resources for data visualization, communications and energy, this escort vehicle is also considered a control room with added cognitive and physical challenges as fatigue, monotony and time pressure [Hilliard and Jamieson, 2007].

Usually, solar racing vehicles reach up to 120km/h, which means each second its moving along 34m road length. Bumps, death animals and traffic may force the team to make fast decisions even if differs from original "plan". This adds a high unpredictable behavior on the race dynamics, even if vehicle dynamics is highly predictable. So, Operators depends on early recognition of differences

in the usual vehicle and environmental behavior, and must react to new, in critical cases, mainly unknown situations[Wittenberg, 2004].

Inconsistencies or delays on displayed information to Operators causes mistakes and non optimal operation, causing the vehicle to stop at unscheduled times or places due to reduction in its efficiency. In the context of space missions, propagation delays can be as high as 160 minutes due to vast distances and low bandwidth communication systems, with frequently losing of telemetry link, forcing the MC to analyse large amounts of previous data to keep the process (or the vehicle) in stable condition[Sollazzo et al., 1995].

Sometimes, computed aided simulations, models and estimations are needed to deal with low quality data or even a lack of it, with a risky operation of "*wait and see*" instead of real time monitored and fully-controlled process [Schilling, 1995]. Therefore, as high bandwidth and high speed telemetry links are available to track race vehicles from a escorting "control room", Race teams base their decisions from reliable data gathered from the car [Boulgakov, 2012], and although computational models predicts vehicle behavior closely, accurate knowledge of the process behavior is crucial [McCarthy et al., 2000].

In missions where response time and decision-making is critical (either solar vehicles or space probes), the time it takes to Mission Control Team (MCT) to process raw data and complex information is very small and can result in errors and delays that can affect the performance of the mission [Horvitz and Barry, 1995]. The large amount of information received by the Operators, coupled with datalink problems and communication delays involve a heavy workload for staff [Sollazzo et al., 1995, Hilliard and Jamieson, 2008]. In case of fault situations or unpredictable behaviors of the process, Operators should receive accurate and easily understandable information, to react properly to these situations [Wittenberg, 2004]. It is crucial to obtain as much high quality information as possible on both, the performance of the mission, as the current state of the vehicle [McCarthy et al., 2000].

In addition, the decision-making for the process is based on the Operator's knowledge of vehicle behavior, mission objectives and possible failures or anomalies. Moreover, as the mission objectives are met, new knowledge that serves to optimize future missions is built. This knowledge can be lost due to staff turnover [Van Baar et al., 2014] and poor documentation of processes so the expertise race strategy is very difficult to achieve [Hilliard and Jamieson, 2007].

## **1.2 Research question**

How complex systems as those controlled in MCC can be monitored in a more efficient way by simplifying and reducing the set of sampled data into a smaller set of relevant data, without compromising the fulfillment of the process objectives?

## **1.3 Project Objectives**

### **1.3.1 General objective**

To design an Information Management Method, based on a Knowledge Management (KM) approach, to select process relevant data for Human Supervisory Control (HSC).

### **1.3.2 Specific objectives**

1. To identify mission factors which influence its completion like goals, functions, required available technical resources/constraints
2. To develop technical and logical steps of management information method based on Knowledge Management (KM) Approach.
3. To apply the proposed method on a mission control (racing solar electric vehicle).
4. To evaluate the influence of mission objectives and tasks on variable relevance through operational stages.

## **1.4 Research Scope**

The scope of the research project is to evaluate a method to formalize the analysis and selection of monitored system variables in Human Supervised Control Applications. The results of the method (Reduced set of process variables and their properties) can be used as an input for the generation of expert systems and Human to Machine Interfaces, but this subsequent stage goes beyond the scope of this work. This work does not include the analysis of failure states of the process. The operating states of the system will be analyzed when the operation of the system is normal.

## 1.5 Research Approach - Design Inclusive Research (DIR)

In research, when it is desired to propose new alternatives to the solution of a problem, the research process must be contextualized in such a way that the new knowledge can be applied more effectively to the problem, and also generalize it to solve any other problem. For this, manifestations of design (as a form of contextualization) are included in the research process. The strongest contextualization of scientific knowledge can be achieved through design so that the research process takes place in design processes that may, eventually, lead to products or artifacts.

The motivation of the postgraduate project stem from inconveniences and opportunities with respect to HSC systems evident during the design and construction of a solar vehicle to participate in the World Solar Challenge 2013. With the intention of participating in the 2015 edition by applying improvements to the new vehicle, including the application off the proposed method, Design Inclusive Research (DIR) methodology was chosen. DIR process is shown in Fig. 1.4.

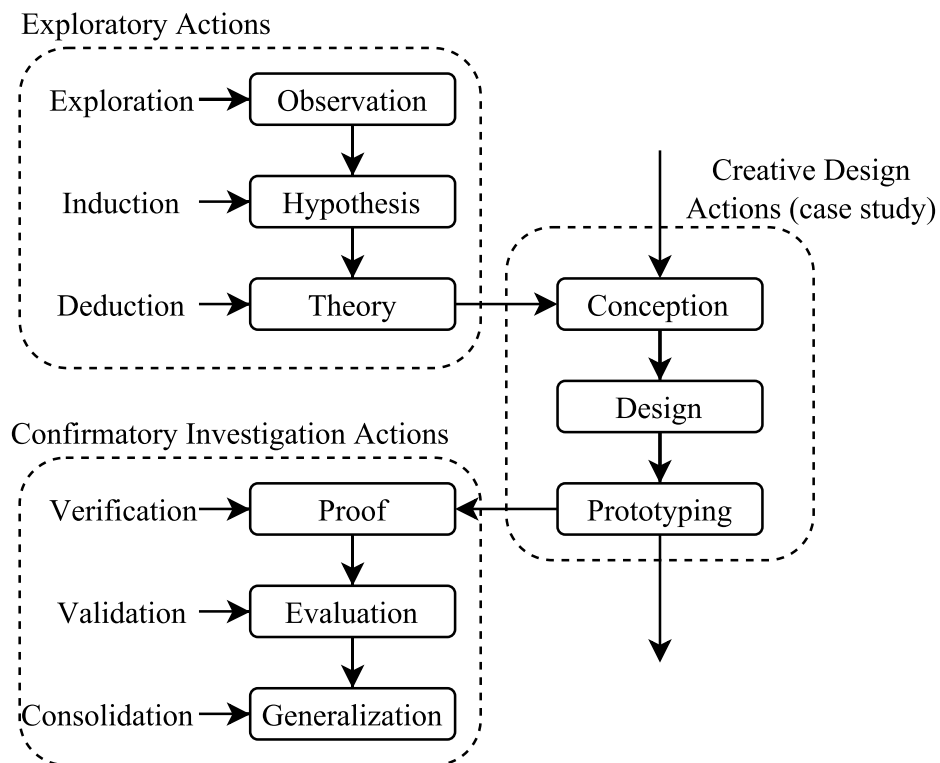

Figure 1.4: Design Inclusive Research Methodology major phases [Imre, 2007]

DIR is composed of three main phases. The first is the *Phase of Exploratory Actions*, where the exploration of the problem is realized, as well as the generation of possible hypotheses for the

resolution of the problem, and eventually the generation of a theory. also state of the art and previous approaches were included to support the context of the problem.

The second, known as the *Phase of Creative Design Actions*, consists of the generation of artifacts or processes supported in the design process. This artifact, which can be a model, a methodology, or a concept, allows generating conditions where the artifact can be evaluated. For the case of the research project, it is proposed to apply the device in the case of the Solar Vehicle that competed in the World Solar Challenge 2015.

The final phase, or *Confirmatory Investigation Actions*, allows the verification of the assumptions put to the test during the implementation in the case study, in addition to the validation of the results, and eventually, making the corresponding adjustments, generalize the artifact, which can be applied in another context. For the case of the research project, it is intended that this method, may have application beyond the case study of the project [Imre, 2007].



## Chapter 2

# State of the Art

Many of the developments in control of complex systems or processes through the remote monitoring of variables were born with the birth of space exploration, where the environmental conditions as well as the complexity of the tasks in the space detonated the development of telemetry systems and supervised control protocols, which today we take for granted, not only in aerospace applications, but also in the control of industrial, aeronautical, biomedical and motor sports processes, to name a few. Thinking on the mission control system as a system where information is processed, calculated, deployed, stored and managed, in close interaction with human Operators that makes decisions, this Expert-Machine interaction could be called a knowledge-based system (as a transfer process), although the strict concept speaks about the automation of operator reasoning included within the monitoring system through heuristic rules [Studer et al., 1998].

Considering the control system (Human-Machine interaction), from the organizational point of view, it is required that the mission Operators receive information of the best quality possible, at the right time. previous data and learnings also may influence future actions. This process of information management in the organizational field is known as Knowledge Management [Sveiby, 1997, Skyrme, 1997, Litvaj and Stancekova, 2015].

Success in tasks that need to be performed through human supervised control depends on several factors:

- The relevance of the information being analyzed (right data, received at the right place and time).
- Operators must assimilate the information (required data must be shown in the simplest possible way and reflect the state of the process)

- The information that is received has a direct impact in the fulfillment of the objectives of the process.

Aspects that combine the technical capacities foreseen in the Knowledge Engineering and the organizational planning of the Knowledge Management.

The following subsections are a brief compilation of works in which the assumptions of Knowledge Management (KM) and Knowledge Engineering (KE) regarding the management, selection, and deployment of information are put into practice. Taking as a main reference the works carried out in the aerospace sector.

## 2.1 Human Supervisory Control

Human Supervisory Control (HSC) is responsible for analyzing the interaction between machine-based systems and operators. Such interaction is necessary when it is required that the process needs to be executed in accordance with the Operator's guidelines, and where the machine or process is not completely autonomous and requires some intervention by the Operator. Human-machine interaction is usually done through graphical interfaces known as Human-Machine Interface (HMI), which displays alphanumeric or graphical information. The success of the operation depends on if the information displayed in the HMI is correct, is adequate and sufficient. Problems during Human-Machine interaction generate errors that cause considerable economic or human losses [Lind, 1999, Sheridan, 1992].

The elements composing a human-supervised control system are shown in Fig. 2.1. The task, process, mission or technical system is generally isolated or covered and its current status can not be readily recognized or even creates a safety risk for personnel. This is why, through instrumentation and actuators, the information of the monitored variables (water level in a tank, temperature of a compound, rotation speed of a drum, etc.) is received, as well as control actions in the system (for example, opening or closing a valve, turning on or off an engine, regulating the temperature through a burner, etc.). Data leaving the process (instrument data) and data entering the process (control action signals), are processed in a computerized system, which is responsible for transmitting (either through cables or wireless links) and converted in easy-to-process signals via HMI graphic interfaces and control signals from levers, buttons or even the HMI itself. It is in the HMI where the operator interacts with the system, so the shown information is fundamental to the operation of the system [Sheridan, 1992].

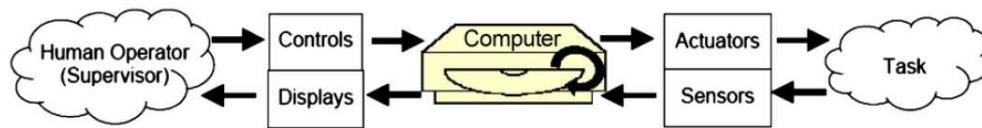

Figure 2.1: Human Supervisory Control simplified scheme.[Sheridan, 1992]

### 2.1.1 Contribution of Space Program to Human Supervisory Control Systems

Since the launch of the first artificial satellite, The Sputnik in 1957, and even until the arrival of man to the moon with the *Apollo* program missions, telemetry systems began to evolve from sending information through modulation of audio or video in short frames [Divine, 1993], to more complex, high speed, high amount of data links. During early stages of space exploration, the priority was to bring a crew to space and keep it alive. The challenges that brought the arrival to other planets farther than the moon forced the development of unmanned aircraft with a higher degree of sophistication and higher levels of automation, allowing them to perform the same exploration tasks of a on-board crew, but with ground control personnel. This brought a cost. A greater amount of data that was transmitted to earth and a greater number of variables monitored, faster. During interplanetary missions, the transmission times increases due to higher distances (from a few minutes to hours), preventing ground engineers from being able to know the actual, real time status of the vehicle. In addition, extended periods of operation and exposure to extreme environmental conditions (high temperature changes, radiation, micro-meteorite impacts, etc) increase the number of redundant systems needed to be monitored. This requires the installation of a greater amount of instruments (and therefore, monitoring of more variables). In conclusion, ground operators perform their activities with greater uncertainty about the current state of the ship and mission tasks completion, only depending on the information they receive to be able to operate the mission tasks [Schilling, 1995, Sollazzo et al., 1995].

As a first step, and, in the case of the *Cassini Huygens* probe [Sollazzo et al., 1995, Schilling, 1995], technical automatism were implemented to help controlling its basic on-board functions (those should be carried out in real time like temperature control and power management), but those scientific nature tasks of the mission should remain monitored and controlled by ground scientists. This Human Supervisory Control scheme, delivers part of the responsibility for mission tasks to automated systems, supervised by highly qualified personnel through information visualization systems. The levels of automation (LOA) of the mission, which determine the amount of information that is shown to the crew as to the personnel on the ground and the degree of control they have on mission

tasks [Sim et al., 2008]. The greater the amount of information, the greater the awareness of ground controllers in relation to the ongoing mission. The cost of this scheme is the complexity of handling large amounts of data. To a greater degree of automation, less information on the ground is required to be processed and analyzed, with the cost of the mission's loss of consciousness and usual "out of protocols" responses to adverse events, although it was found by some authors that stress level on ground operators of highly automated systems decreases [Roma et al., 2013]. This situation is parodied in a caricature of manually and highly automated Apollo Command Module, from MIT Instrumentation Lab, as shown in Fig. 2.2

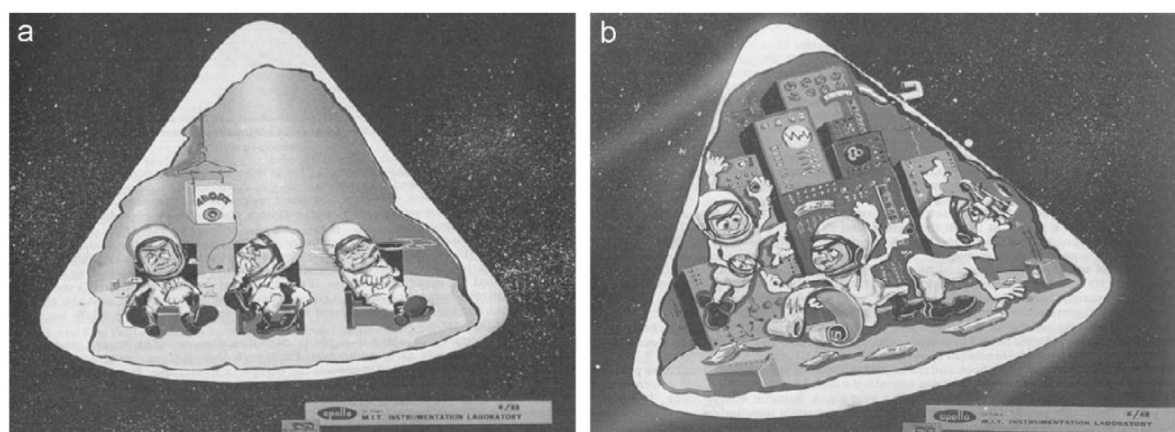

Figure 2.2: Caricature of (a) completely automated, and (b) manually controlled Apollo Command Module [Sim et al., 2008].

In response, *NASA* and other agencies have sought ways to facilitate the task of Human Supervisory Control, especially in more complex missions, and in turn, reducing operating costs as the missions become more complex. *NASA* has not only focused on solving technical uncertainties, but has also sought solutions from the strategic and mission planning arena, seeking to solve two main problems:

1. Reduce costs and increase the flexibility of operation for each mission.
2. Look for strategies that improve the way the mission information is managed and deployed to both ground operators and on-board crew.

*NASA* has had to substantially change the way in which it manages and operates its missions, mainly due to the reduction in the available budget for the space exploration programs. The conscientious planning of the mission starting from the strategic analysis and the technical analysis, even without having a formally approved project. For this, *NASA* has leveraged several methodologies:

### 2.1.1.1 Space Mission Analysis and Design (SMAD)

Space Mission Analysis and Design Process (SMAD)[Larson and Wertz, 1992], compiles experiences in designing, operating and deploying *NASA* missions during the first 40 years of space exploration. The method concentrates on the iterative execution of four successive steps, starting from the definition of the mission statement.

1. Defining mission objectives and their constraints, as well as the estimation of needs and quantitative requirements extracted mainly from the mission statement, and associated success criteria.
2. Characterizing the mission, with the definition of mission concepts and possible architectures.
3. Evaluating the mission, by identifying critical requirements, mission schedules and mission utility, including conceptual design of technical systems, communications, operations, etc.
4. Defining system requirements, and comparing possible combinations of mission architectures that reduces costs to a minimum.

This process is analyzed at all levels, from administrative and operational, to the technical and engineering level. The major contribution of SMAD to *NASA* mission operations is that concept generation and definition of mission systems are based on an in-depth analysis of the mission statement as well as the objectives, success criteria, and constraints of all to ensure that mission objectives are achieved satisfactorily[Larson and Wertz, 1992].

### 2.1.1.2 NASA Systems Engineering and Human Factors Engineering (HFE)

More recently, *NASA* recorded in the book *NASA Systems Engineering Handbook* Shishko and Aster [1995] the procedures for the design of missions. The flow of requirements for the design of the technical systems of the mission must start from the mission objectives and its requirements, and the definition of the functions that must fulfill both, the technical system and the human team in charge of operation tasks. The study of the requirements and impact of people and their capabilities in mission operations is also included and is known as Human Factors (HF) Engineering, from four fronts:

- Selection of personnel (in order to find the most ideal person for the realization of the Task)
- Design of the system, the interface and the task to be performed (increasing system resistance to errors and easing learning)
- Personnel training
- Optimization of procedures.[Shishko and Aster, 1995].

HFE is focused on analyzing the link between people and the technical systems, also called monitoring interfaces and mission control systems. Its interaction with NASA programs is shown in Fig. 2.3

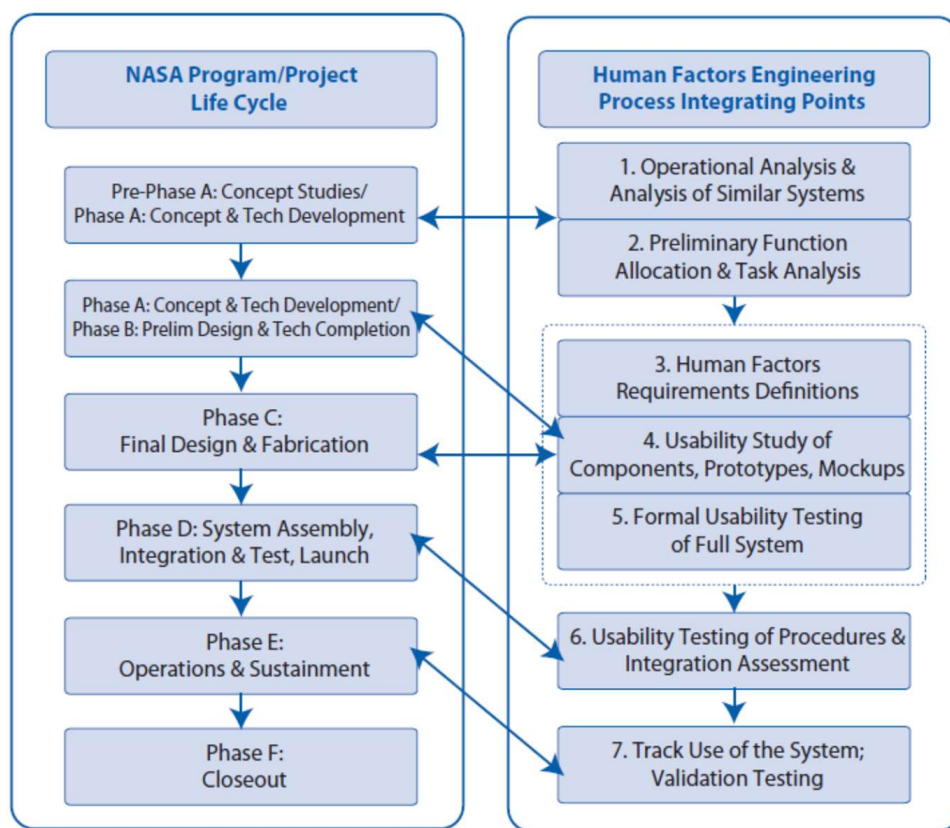

Figure 2.3: NASA Human Factors Engineering process [Shishko and Aster, 1995]

In a similar way to the work in NASA, Viscio and Viola [Viscio et al., 2015] propose the definition of technical requirements based on the analysis of mission objectives from the mission declaration. Is based on the analysis of mission operational stages using Functional Flow Block Diagrams(FFBD) [Shishko and Aster, 1995] where, based on the systems requirements for the fulfillment of the mission objectives (known as Building Blocks, technical requirements of mission were defined [Viscio et al., 2015].

This approach was also proposed by Geng [Geng et al., 2016] who, through the analysis of mission objectives, finds the relationships between mission and the system, passing through the study of system functions from the point of view of the relations between the mission requirements and the capabilities of the system. The deterioration or improvement of these system capacities, or health

of the system, has a direct influence on the results of the execution of the mission, then the constant monitoring and real-time health status of the systems allows the mission controllers have high awareness about the state of the ship (or process) and, therefore, achieve the mission objectives [Geng et al., 2016]. To establish the relationships that exist between the mission and the system, first establishes relationships between the mission and the functions of the system through function decomposition trees, taking into account the functions required for the execution of a mission without problems, and a problematic mission (health problems) tree. Because the analysis is carried out in a hierarchical way, there are functions and sub-functions that have greater relative importance than others, so that the authors use the Hierarchical Analytical Process (HAP) [Vaidya and Kumar, 2006, Saaty, 2008], qualifying the functions with quantitative levels of importance, based on qualitative definitions. This information is loaded in a Health Prognosis and Management (PHM) model, which analyzes the possible combinations of subsystem health states, and evaluates which of these cases provides the best mission performance [Geng et al., 2016].

### **2.1.1.3 Expected Information Indicators**

Various approaches applied to information deployment systems have been proposed. The information being monitored (i.e. in the OMS or Orbital Maneuver System of the space shuttle as shown in Figure 2.4) comes from sensors and meters and ground operators must read into the values and decide whether to act or not and which way. These values do not give indications about the state of operation of the equipment and it is uncertain whether the decisions that are taken from deployed information is adequate or not.

Eric Horwitz of the Microsoft Decision Theory Group and Matthew Barry of NASA's Johnson Space Center propose a graphical interface system based on the Expected Value of Received Information (EVRI) indicators and Value Expected from Displayed Information (EVDI) [Horvitz and Barry, 1995].

EVRI is a metric of the amount of additional information that, although available, is not included in the analysis for decision making. The amount of information that is included is defined through a probability distribution, and without considering the amount of information that is shown to the expert to make the decision. More generally, EVDI takes into account the amount of information that is shown to the expert for decision making. These indicators give indications about the cost of showing or not showing a certain amount of information and its impact on the appropriate or non-

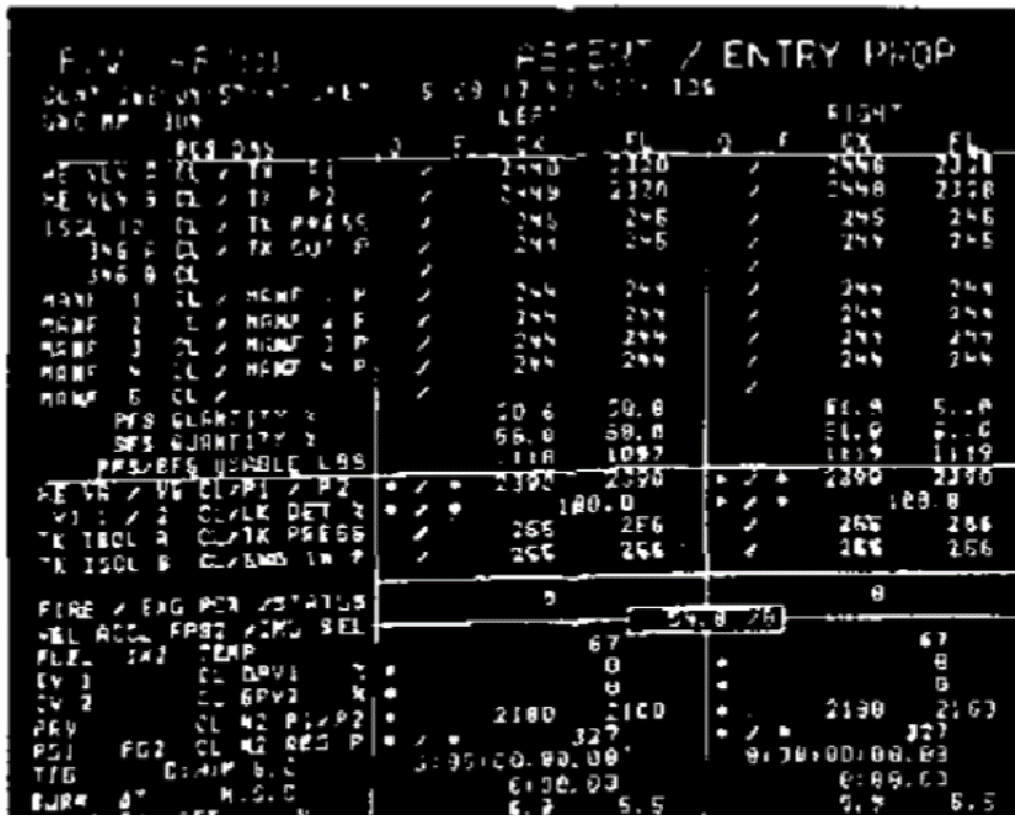

Figure 2.4: Primary screen of the Space Shuttle propulsion subsystems [Horvitz and Barry, 1995].

decision making.

Applying changes to the traditional Graphic User Interface (GUI) of the space shuttle, a first prototype interface called *Vista I* was created (seen in Figure 2.5) which allows the adjustment of amount of information shown to user (in run-time), besides being flexible and allowing to configure the screen that is used, match each variable requirements [Horvitz and Barry, 1995].

Although the authors have implemented changes and presented the *Vista-III* version of the prototype, they find that the EVRI and EVDI metrics are not suitable for highlighting information (e.g. colored alarm signals) depending on the situation or the user. Also authors were concerned about the ease of implementation of an EVDI-based model and propose the development of new information selection models based on Bayesian networks.

Similar to the proposal of Horvitz and Barry, NASA initiated in 1999 the program of Cockpit Avionics Update (CAU) for Space Shuttle missions, looking to replace the old visualization systems based on mechanical Gauges and signal lights. Focusing on systems information needed to be displayed to the on-board crew. The CAU program was canceled in 2004 for lack of funds, and due to

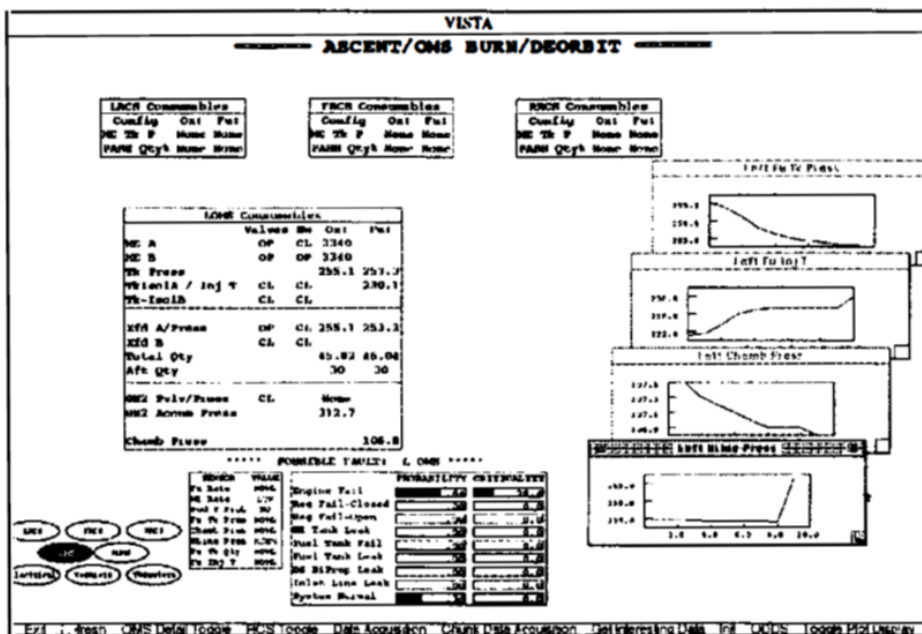

Figure 2.5: Primary screen of the Space Shuttle propulsion subsystems Showing expanded OMS from the screen manager [Horvitz and Barry, 1995].

the subsequent shut down of Space Shuttle program in 2010 [Sim et al., 2008].

### 2.1.1.4 Mission Control Technologies

A more recent approach to solving the information management problem at NASA is known as a Mission Control Technologies or MCT project [Trimble et al., 2006]. At present, the software applications on which the different information management and information systems runs are generally proprietary to each developer, and are based entirely on the technical re-queries of the system being monitored, being the Operator an application client. When a change in mission requirements is required, new applications are being developed under new specifications and can not be effectively communicated with other mission applications. This gives rise to the involuntary generation of functional copies and the non-standardization of control interfaces, form of information deployment, etc. With the mission control technologies project, NASA intends to flexibly unify these applications so that the cost of integration and modification for new missions is lower, and that mission controllers decide the appropriate way to manage that information. MCT proposes the conversion of objects in a programming language to components with mission-to-mission flexibilization properties, and are customized according to the mission’s needs and the role of each operator [Trimble et al., 2006].

NASA highlights the importance of flexibilizing their information systems with the use of MCT, using the same mission controllers as architects who are responsible for categorizing and modifying the variables and information they receive, similar to how Digital Encyclopedia *Wikipedia* does the construction of Shared knowledge (process known as Social Productivity) [Webster et al., 2012].

### **2.1.2 Industrial applications: Virtual Process Visualization Concept (VPVC)**

The levels of automation have also increased in the industrial field. The introduction of the Programmable Logic Computer (PLC), improvements in instrumentation and the arrival of robotics in industrial processes have been able to reduce operating costs as well as production times and has increased the responsibility of operators to the process. The monitoring and control of the plants in centers of operation have been a focus that works with principles similar to those of the centers of control of the mission. The link between the operator and the process is made through graphical interfaces, on which the operator is fully aware of the process. Due to the complexity of industrial processes, the amount of information shown must be strictly necessary to execute the steps of the process, and not necessarily the amount of information allows to reach a level of awareness of the process suitable for monitoring and control.

Concepts of information deployment based on Human Decision models have been applied, where through initial observations of information-processing, people act-plan accordingly, based on how they relate their own knowledge (of people) with the information that is on the screen [Rasmussen, 1986]. The greater the similarity between the two, the better the information processing. Therefore, this information is understood more effectively by the operator. For this, Wittenberg [Wittenberg, 2004] proposes the Virtual Process Visualization Concept (VPVC), which mixes graphic elements according to the process or knowledge domain belonging to the process, with quantitative status variables, and with a full differentiation of process tasks and relations between them. In terms of the states of the tasks, the use of colors semaphore type allows to quickly determine the status of each task, and identify those that are with deviations. The proposal offers great advantages over non-graphical information visualization systems, but it has the drawback of being demanding for processes where there is no possible graphic representation on the screen [Wittenberg, 2004]. A process interface made out of VPVC principles is compared to an standard, Topological interface as shown in Fig. 2.6

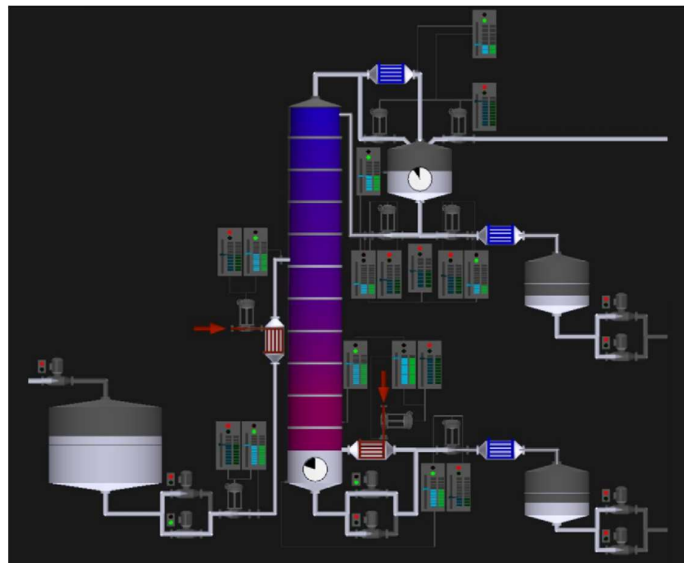

(a)

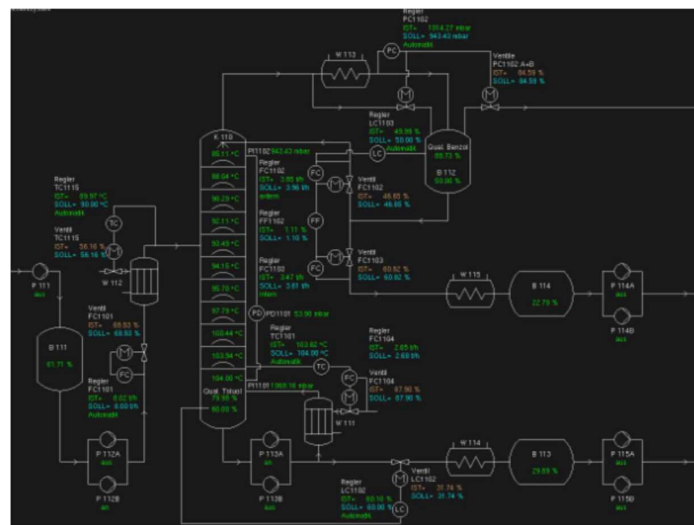

(b)

Figure 2.6: Process Overview designed by VPVC Concept 2.6(a). Standard Topological Interface 2.6(b). [Wittenberg, 2004]

### 2.1.3 Automotive Applications - Solar Electric Vehicles

A solar vehicle is an electric vehicle that uses a photovoltaic array to generate part of the operating energy, which is stored in a battery. Due to the characteristics of the solar panel (where the total generation efficiency oscillates between 18% and 23% and there are restrictions of volume and weight

for energy storage, it is necessary to reduce the consumption of the vehicle to the minimum (optimizing the aerodynamic, mechanic and electric design) through a race strategy. This takes into account environmental and topographic conditions and is feed to the escort vehicle through a Telemetry System. In the escort vehicle MC functions resemble those performed by Operators; even having visual contact with the vehicle all time.

The characteristics of this class of vehicles make them impractical for commercial use, but they are intended as a development platform for emerging technologies, of great interest to the automotive sector and academia. (World Solar Challenge in Australia<sup>1</sup>, American Solar Challenge in the United States<sup>2</sup>, and other high-energy competitions in Japan<sup>3</sup>, South Africa<sup>4</sup> and Chile<sup>5</sup>, to mention some).

Mission Control of racing solar vehicles is specially difficult because although during the competitions, the telemetry link sends data almost in real time but the speed of the vehicle reduces the decision making time. Changing conditions of solar and escort vehicles is also challenging. Then several management strategies and information deployment designs must be arranged.

Since the beginning of the World Solar Challenge in 1987 (the oldest solar car race in the world), university teams in collaboration with the automotive industry have implemented variable monitoring and telemetry systems in their vehicles. A rudimentary monitoring system applied to the *Honda Dream* 1993 vehicle implemented a PC-based monitoring system where information is selectively displayed for each operator, with the inconvenience of race strategy calculation made by hand based on historical information processed in *Microsoft Excel* [Shimizu et al., 1998].

Subsequently, in 2000, Louis McCarthy and the University of Missouri-Rolla solar vehicle team proposed the development of an instrumentation-based user interface with a Digital Signal Processor and precision sensor. In addition, they installed a panel of displays for the measurement of variables of the solar panel, monitoring up to 20 sub-modules at the time. These measurements in parallel allow the pilot to know the state of the solar panel, as shown in Fig. 2.7

Information from the vehicle was sent to the support vehicle via a radio frequency module and displayed to the strategy team via a numerical graphical interface, showing the main vehicle performance values such as Speed, Battery Voltage and Input and output currents in the vehicle, as shown

---

<sup>1</sup>Bridgestone World Solar Challenge - <https://www.worldsolarchallenge.org/>

<sup>2</sup>American Solar Challenge - <http://americansolarchallenge.org/>

<sup>3</sup> Suzuka Solar Car Race - <http://www.fia.com/championship/events/alternative-energies-cup/season-2016/solar-car-race-suzuka-2016>

<sup>4</sup>Sasol Solar Challenge - <http://www.solarchallenge.org.za/>

<sup>5</sup>Carrera Solar Atacama - <http://www.carrerasolar.com/>

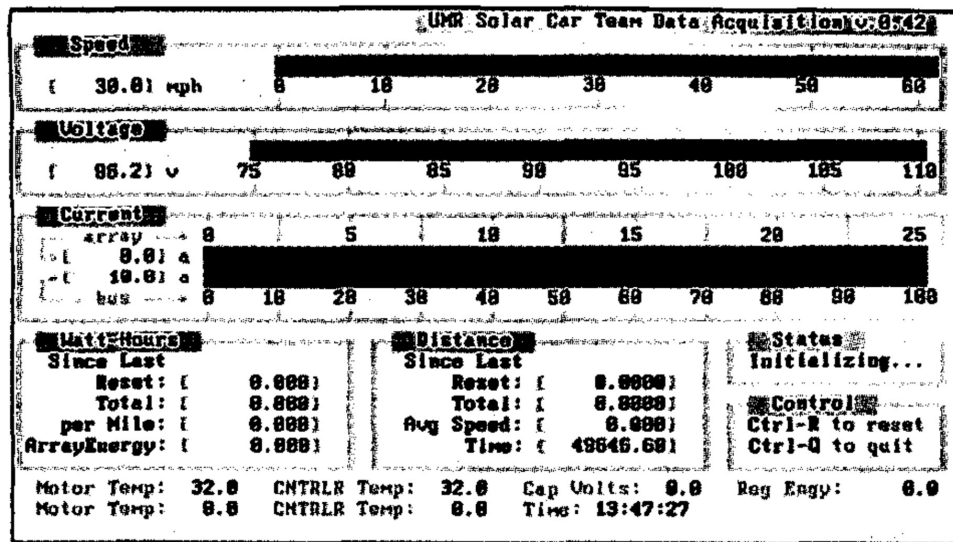

Figure 2.7: GUI designed for University of Missouri-Rolla Solar Vehicle in 1999 [McCarthy et al., 2000].

in Fig. 2.7, without exposing clear criteria for selecting variables or relevancy of the information that was displayed. Although the graphical interface and the solar panel measurement module helped the team to successfully complete competition tests, the lack of instrumentation in key systems such as Maximum Power Point Tracker (MPPT), motors and battery makes it very difficult to detect errors and problems in these subsystems, forcing the team to stop the vehicle and lose race positions.

Subsequent projects of solar vehicle equipment included the use of commercial integration and systems development software, such as the equipment of the product design and manufacturing center (CPDM) of the University of Malaysia, which for their Merdeka vehicles 1 and Merdeka 2 used *Labview* as a platform for acquiring and deploying vehicle information [Taha et al., 2010a,b, 2008].

#### 2.1.4 Ecological Design of Interfaces (EID)

According to Hilliard and Jamieson [Hilliard and Jamieson, 2007, 2008] of the University of Toronto, the design of a graphical interface of strategy in a solar vehicle has three main objectives:

1. To help efficient understanding of the vehicle behavior in terms of its energy inputs and outputs.
2. To help in the early identification of faults.
3. To allow accessibility to non-expert users helping them to develop such expertise.

They propose the design of a graphical interface based on the methodology of Ecological Design of Interfaces (EID) [Burns and Hajdukiewicz, 2013] for the strategy team of the solar vehicle BlueSky. EID is based on the identification of Semantic Fields through Work Domain Analysis (WDA), which defines levels of information abstraction, in a manner similar to that used by people to solve problems intuitively. In the analysis of the main sets in a competition of solar vehicles, they find three main ones: The whole of the vehicle, the set of natural environment and the set of the environment of competition. These sets enabled to define all the variables that affect the operation of the vehicle and its performance in the competition. These sets are specified in Figure 2.8.

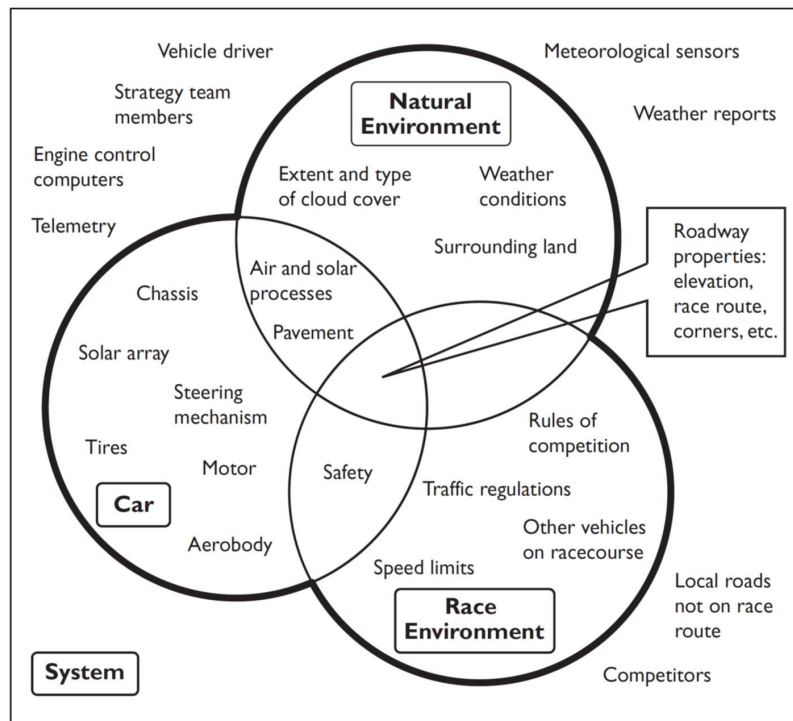

Figure 2.8: Work domain boundaries proposed for a Solar Vehicle [Hilliard and Jamieson, 2007].

These levels of abstraction range from the identification of basic concrete elements such as mechanical behavior, intermediate elements (such as the impact of the motors) and advanced ones (such as the safe handling of the vehicle and efficient handling to achieve the victory in the competition). They also suggest that, as in the design of the vehicle from all its subsystems, the use of physical laws, mathematical equations and postulates, should be maintained as analogies in the user interface within the levels of abstraction.

They propose a GUI system based on 4 WDA domains: Navigation Information, focused on the speed of the vehicle and race conditions. Safety features, including vehicle maneuverability and fatigue measurements in subsystems. Mechanics through detailed vehicle instrumentation; and Energy in terms of the net energy balance of the vehicle (energy input and output from the solar panel and to the motor), as shown in Figure 2.9.

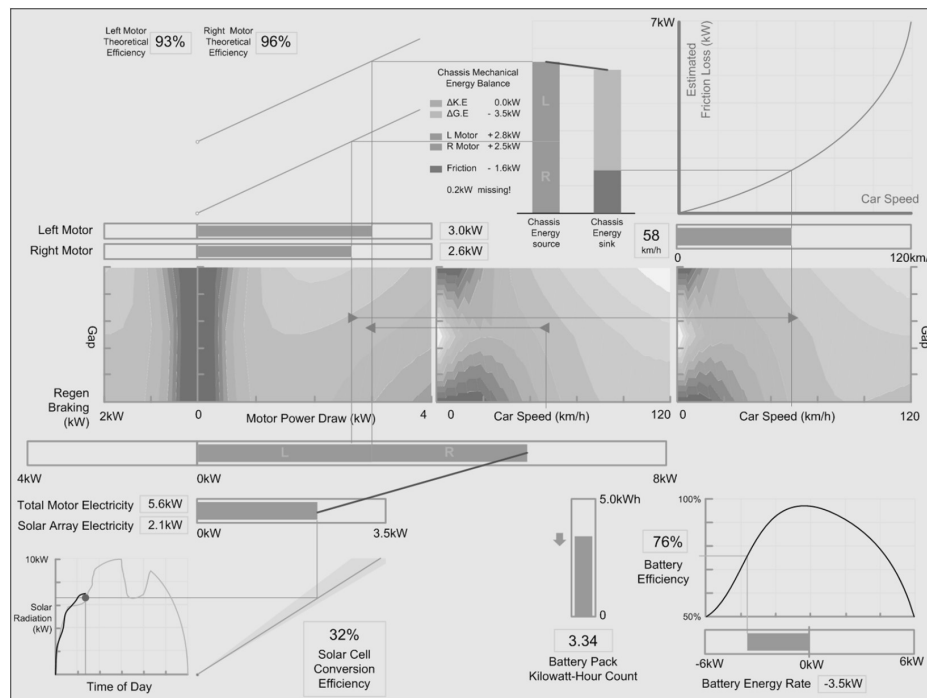

Figure 2.9: Energy GUI Prototype for BluSky Solar Vehicle [Hilliard and Jamieson, 2008].

Although the EID facilitates understanding of the current state of the vehicle, the information is shown in terms of physical phenomena and bidimensional graphs requiring basic knowledge of physics and mathematics, being a barrier to non-experienced users.

The authors do not specify a mechanism for storing the information for future review, nor how the prior information is assimilated to new competition teams that are not aware of the behavior of the vehicle or even about the factors that impact the competing result.

### 2.1.5 Maintenance over time

Isha Van Baar together with other students from the Delft University of Technology in the Netherlands, proposes the design of a graphic interface that can be maintained over time. They identified a problem in the design of their data capture system (taking as reference the one installed in NUNA7,

participant of the World Solar Challenge 2013). Both maintenance and upgrades to vehicle monitoring software can only be done by the developer. Poor software documentation prevents software upgrades from occurring and requires the development of a new one at a time. They also identified that the personnel arriving at the project each season require an extensive period of training and that the constant development of career applications prevents the construction of knowledge that can be applied in future competencies.

As a solution, they established categories of information focused on the analysis of subsystems, (Shown in their GUI design in Fig. 2.10)

- *General Category* with a summary of the relevant vehicle information.
- *Battery* status of vehicle components and fault alarms and indicators.
- *Meteorology* including information about the vehicle's weather conditions.
- *Route* information related to the road and race position.
- Historical data.

This proposal is similar to energy balance measurement (from WDA) proposed by Hilliard and Jamieson [Hilliard and Jamieson, 2007, 2008] shows information about the current flow between the solar panel, the battery and the engine of the vehicle [Van Baar et al., 2014].

Although the proposal for NUNA7 uses graphic elements as icons and symbols on a schematic design of the vehicle, it still uses numerical and graphical indicators in two dimensions to display the information, which requires engineering knowledge and involves knowing in detail the dynamics of the vehicle. Unlike the BlueSky proposal, which includes information on the vehicle's known characteristics as a reference (e.g. maximum motor power and solar panel efficiencies, etc.), NUNA Proposal is similar to VPVC approach described by Wittenberg [Wittenberg, 2004].

## 2.2 Knowledge Management (KM) Approach

In human-supervised control, the HMI is responsible for providing the information necessary for the operator to make a decision that affects the operation of the process or the technical system. When the operator bases its decisions on the alphanumeric information of the HMI, it can be considered as a Decision Support System (DSS). In general terms, the DSS comprises all those software tools or hardware that deliver information in the form of numerical data, graphics or models. The information is managed through databases and operated in a certain way to create a model about the operation of the process, it is said that the DSS is based on knowledge [Shen, 1987]. Knowledge becomes the main

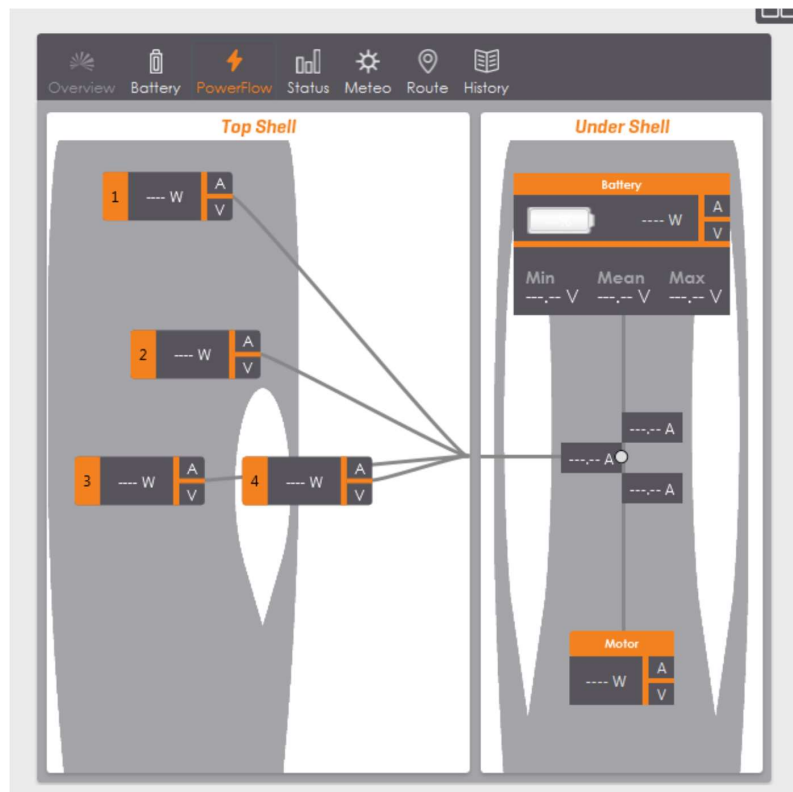

Figure 2.10: Powerflow tab of the Solar Vehicle from TUDelft [Van Baar et al., 2014].

input for the HSC system, focusing all of its efforts to reach common objectives, the same way an organization does. Then, the process of building organizational knowledge that is achieved through KM should also be considered for MCC.

### 2.2.1 Knowledge management (KM) in the organizational field.

Knowledge management is the art of creating value in an organization from its intangible assets, that is, knowledge through the execution of two main activities: managing information (e.g. converting knowledge into tangible objects) and managing the personnel involved in the process [Sveiby, 1997], being an explicit and systematic process [Skyrme, 1997], focused on the deliberate construction, renovation and application of organizational knowledge [Wiig, 1997]. Is responsible for channeling all those tasks to create conditions of identification, obtaining, maintenance and use of intellectual capital [Litvaj and Stancekova, 2015].

To consider if a Knowledge Management process is successful, it must achieve the following objectives: display (information) at the right moment, in the right place and to the right person, in

the most appropriate way possible, meeting the expected quality requirements and that all this can be done with the lowest cost possible.

For this, it is necessary to make an inventory of the knowledge available through the identification of organizational processes, as well as their relationship or contribution in the fulfillment of the stated objectives. This inventory of knowledge is done through surveys or interviews with knowledge agents, or collaborators. Such knowledge inventory is then reviewed, distributed or developed to its respective (or involved) agents, and decisions are made. The repetition of these steps is known as the KM Cycle [Wiig et al., 1997, Dieng et al., 1999].

Other approaches shows knowledge as a tool that can be marketable, based on 4 stages:

1. *Construction* (to make knowledge).
2. *Embodiment* (to make knowledge explicit both in operational processes and in the relation of people to systems, and that can Be quantifiable).
3. *Dissemination* (making the knowledge available to the agents in charge).
4. *Use of knowledge* in organizational processes [Demarest, 1997].

### **2.2.2 Knowledge Management in Decision Making**

As knowledge agents are directly involved in building the organizational knowledge base, Knowledge Management can become a tool that increases the quality of decision making. This process can be seen in a simplified way as shown in Fig.2.11. Paprika[Zoltayné Paprika, 2001] defines the process of generating knowledge for decision making based on four main stages:

1. Identification of the context of the problem to be solved based on the objectives to be achieved, the current perceptions and knowledge, as well as the analysis of the current organizational structure.
2. Planning: forecasting possible scenarios including threats and opportunities, monitoring the variables that influence the operation keeping track of those events that can be harmful. From the previous information, to evaluate whether this is relevant or not and if past experiences were relevant to the search for organizational objectives, and if there were problems or adverse situations, identify which decisions were detrimental.
3. Identify decision-making modes in typical routine situations (familiar to knowledge agents)
  - Situations that are not routine (or emergency situations) that force decisions to be made outside the protocols, and where the response must be fast.

- Long-term decision-making based on the search for records to be analyzed (Analysis centred decisions).
  - Conflict management when some agents understand the knowledge in a different way.
  - Construction of collaborative learning through the teamwork of the agents.
4. Decision actions, where the previous steps are implemented through the involvement of the agents in the identification of the problem, the definition of a clear position in front of the problem, the determination of whether current knowledge is sufficient or is required to learn And create new knowledge, and evaluate whether the decisions that are made help build organizational goals [Zoltayné Paprika, 2001].

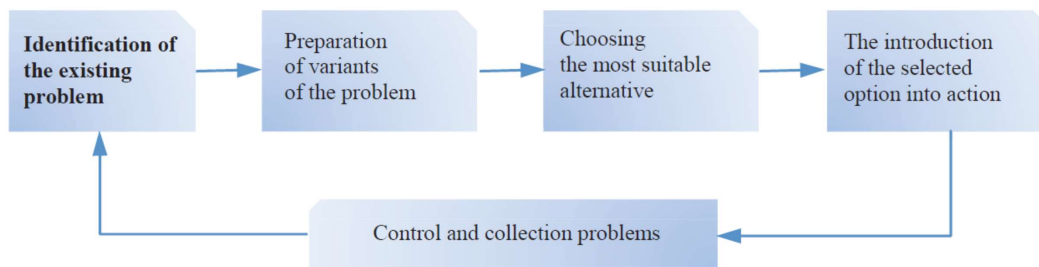

Figure 2.11: Decision Making Process activities in an Organization [Zoltayné Paprika, 2001].

### 2.2.3 The quantity of information vs the quality of information.

There are limits on how much information an operator can process (either through models or data - information relationships). Studies conducted during the 1960s with nutritional products showed that increasing the amount of information available for a person to make decisions is not necessarily beneficial [Quintas et al., 1997]. It is also not beneficial for decision making, having information that is not correct or has inconsistencies. Keller and Staelin [Keller and Staelin, 1987] proposed a model of Decision Choice and Decision Effectiveness, based on the analysis of the ability of information attributes and the quality of available information. They found that increasing the amount of information while the quality of the information remains constant diminish the effectiveness of the decision making process; and that is by increasing the quality of information and keeping the amount of information constant that, the effectiveness in decision-making increases to some extent. Despite the fact that the study was carried out on consumers who made the decision to purchase a food product basing their decision only on a nutritional facts table, it can be related to the decision-making situations in a control room (where decisions are made based on alphanumeric information), although the time and

complexity critically of decision-making increases the difficulty of operations and tasks of a control room [Keller and Staelin, 1987]. For Quintas and Lefrene [Quintas et al., 1997], the amount of information is irrelevant if it is useless for the process. Information excess can be counterproductive if it can not be properly assimilated. Information can be considered a valuable asset since its assimilation and use requires an adequate level of understanding or degree of expertise [Quintas et al., 1997].

#### 2.2.4 Knowledge Management Tools

Because KM is an organized method that allows corporate knowledge to be managed, condensed and required routed to proper agents. Several approaches have been proposed about how technology can facilitate the process of knowledge construction, and how technology relates to people to achieve this end [Liao, 2003]. In purely technical terms, when a technological system is designed to support the construction of corporate knowledge, it is said to be a Knowledge Based System, or KBS [Wiig, 1997]. It usually includes a knowledge base or database (including the creation of mathematical models), an inference system (whether based on logical rules, or decision trees), a knowledge engineering tool, and a graphical interface [Dhaliwal and Benbasat, 1996]. The creation of the model on which a KBS is based, requires the intervention of an expert, but due to the subjectivity and variable criteria of the knowledge agents, generally these models do not fit with the reality of the process, especially if it is being monitored by sensors and controlled by actuators. There is a possibility that certain behaviors of the process can not be predicted by the expert. For this, software tools and methods such as *CommonKADS*, *Protégé*, *ToS*, *MIKE*, *TOM4D* have been developed. Neural Networks or Bayesian Methods allows generating process models of data taken from databases and the knowledge of the expert [Pomponio and Le Goc, 2014].

The way of searching or extracting information from the databases should also be taken into account. Due to the complexity of the management, search and use of large amount of data. This happens very often in industrial process control where the storage and management of the process historical data are crucial, but finding the relevant information is slow or costly. To this end, tools such as Data Mining (DM) [Anand et al., 1996] have been used in order to transform the available data bases into a decision making tool [Hui and Jha, 2000]. In short, the study of the whole compendium of technologies designed from statistical, heuristic or mathematical concepts that process the information of databases including the knowledge of Experts, in context of the industrial process is known as Knowledge Engineering (KE). Is not only focused on generating models from information, but, it

must be able to be used to solve problems [Studer et al., 1998].

## 2.3 Discussion of Previous Approaches

Based on the premise that during the operation of a control room (to handle an industrial process or a mission) including the operation of some technical systems (as in the military or aerospace context, or also in the case of civil applications, and competition vehicles), the success of the mission depends not only on the capacities of, both, Operators and crew, but also on how they are provided with information from the technical system (vehicle, plane, industrial machine, etc.). The fact that operators and process are physically separated (due to complexity, possible security risk or technological limitations), implies that graphical interfaces only will be delivering the information to the operators which determine the decisions to make with respect to the process.

If the information shown is inadequate or insufficient, operators can make decisions that do not correspond to the current state of the process and causing reprocessing or security risks that ultimately undermine the objectives initially established.

If the amount of information is excessive, there is a risk of cognitive overloading of Operators, and mistakes can be made. Finally, there must be a compromise between the quality of the information and the amount of information that is presented to the Operators.

In view of this situation, organizations like *NASA* and others which are involved with the operation of aerospace missions, have proposed methods that study the impact of levels of automation in technical system [Sim et al., 2008], going from a fully human-operated system to a completely controlled by a machine. In both cases, the dependence of the operators on the information is significantly high.

Because decisions that Operators make directly affects the fulfillment of the objectives of the process, the relationship between each of the components involved in the process, from a technical and strategic point of view, has been extensively studied. Capabilities and constraints of equipment and personnel through SMAD [Larson and Wertz, 1992] and how the interaction between humans and machines affects the performance of the process [Shishko and Aster, 1995] that interaction is made possible by a graphical interface, which is based on variables that are obtained from the technical system. At this level, several authors have sought to design such a technical system based on the breakdown of basic requirements and functions that must be completed (FFBD [Shishko and Aster, 1995]) and how these functions relate to the fulfillment of the proposed objectives (Using GFT Approaches [Johnson, 2013, Viscio et al., 2015]). Also, what is the impact on the Process when one of

these functions presents problems (through HPM [Geng et al., 2016]).

It is from these basic functions, that it seeks to obtain data that allow knowing its performance and current state. Determine which variables are relevant or do not depend on both the system designer and the criteria of the Operators, which, although they are carriers of the knowledge, generally their personal criteria or beliefs may influence which variables or data should be used or not for the information system.

Some attempts to address previous problems with respect to mission control systems have been applied in the context of aerospace missions. Processes of statistical type (Expected Information Indicators [Horvitz and Barry, 1995]) measuring the frequency of use of variables by Operators. Different results between Operators becomes unfeasible in high staff turnover scenarios. This causes knowledge losses, which is not acceptable for KM based organizations.

Then, the task of deciding who is responsible for deciding appropriate information to Operators has been for the software developers, among which are manufacturers of instrumentation systems. Long run aerospace agencies such as *NASA* have found themselves in need of finding ways to unify and simplify this instrumentation and information systems (CAU [Sim et al., 2008] and MCT [Trimble et al., 2006]).

In the industrial applications, other approaches have been developed on how the available information of a process should be shown, based on cognitive analysis, as in the case of the VPVC methodology [Rasmussen, 1986, Wittenberg, 2004].

In other contexts, the classification of variables according to their type, application or magnitude has been proposed, as it is done with EID [Hilliard and Jamieson, 2007, 2008], but still having issues about selecting right information with the increasing of useless shown data. Although information classification given by EID is based on process context insights, sometimes is difficult to understand by non qualified personnel.

In summary, the focus has been on improving the properties of HMI shown to Operators, but the selection of the information to be displayed is still selected under the criterion of developers and, in some cases, including the Operators, without clear guidelines on how having or not having such available information may affect the operation of the process and therefore, affecting positively or negatively the fulfillment of the objectives set for the process.

Since Operators of HSC systems are highly dependent on information, KM concepts could be applied suggesting that the information deployment system supports their decision-making process.

And this forces the design of these interfaces to include the right information, at right time, to right Operators. Such selection of information must be done in an explicit and systematic process, involving the Operators and giving them insights about how the process inners (subsystems, operational stages, telemetry systems) impact the fulfillment of the process objectives. Also, based on their knowledge and how they relate the process functions and the systems itself, Operators insights can be obtained. This are the main input for KM construction.

Then, the proposed method shown in the next chapter, allows the Operators to analyze from the technical and strategic point of view, the variable set involved in the process and how affectcs the fulfillment of the objectives, all from their specific knowledge.



## **Chapter 3**

# **Function to Data Matrix (FDM) applied to Mission Control Rooms - Human Supervisory Systems**

This chapter presents the proposed application of the *Function to Data Matrix (FDM)* approach for selecting and weighting process variables for Human Supervisory Control systems. The proposal seeks to analyze the relative importance of the system variables taking into account the operational stages of the process, from the point of view of the fulfillment of the objectives and the available resources of the process. The simplified scheme of the method is shown in Fig.3.1.

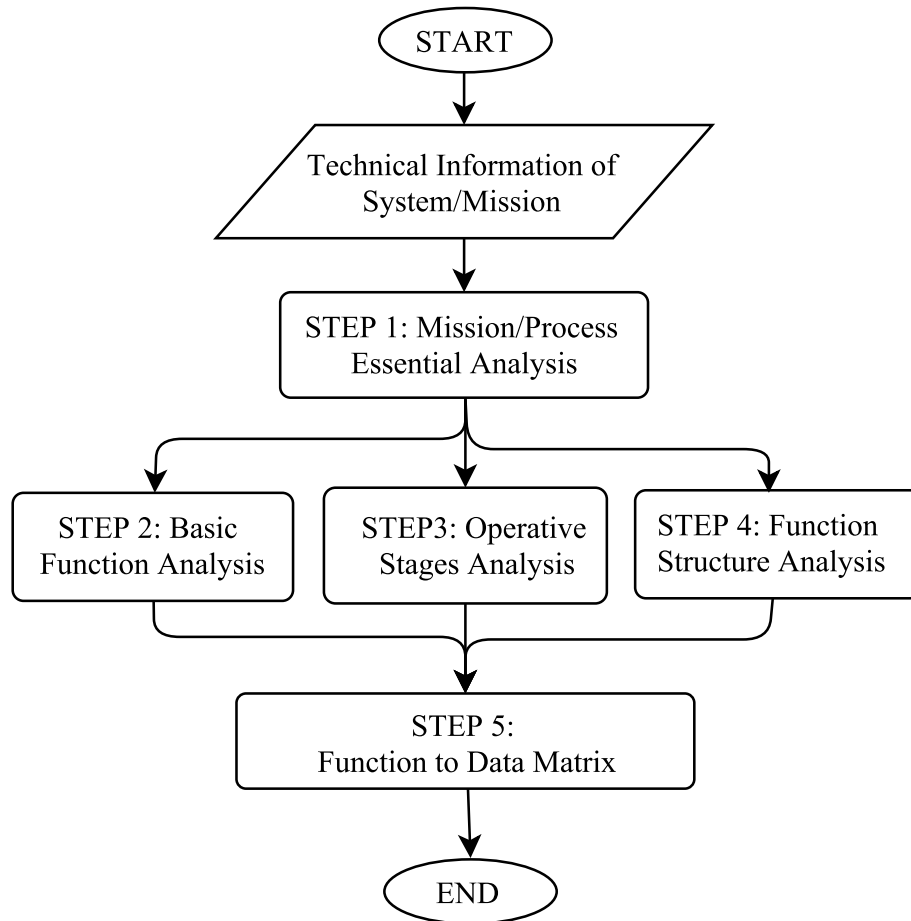

Figure 3.1: Simplified scheme of Function to Data Matrix (FDM) approach applied to Mission Control Rooms

The analysis is done in 5 steps. The first step called *Mission/Process Essential Analysis* seeks to obtain information from the strategic analysis of technical information of the mission, obtaining both mission statement and mission objectives. The second step, *Basic Functions Analysis* seeks to know what functions at the technical level that the system must perform based on the mission that arises, and what is the relationship and importance of these functions with the fulfillment of the objectives, through a hierarchical analysis and weighting of these functions. The third step, *Operational Stages Analysis*, seeks to know what the functions of the system are for each of the operational stages of the process through the matrix of operational stages. The fourth stage, *Function Structure Analysis* of the system seeks to extract the available variables of the system using design methodologies based on functional analysis, where the signal flows that travel in the system are identified and, if required,

sensors are inserted to extract information that is necessary but not directly available.

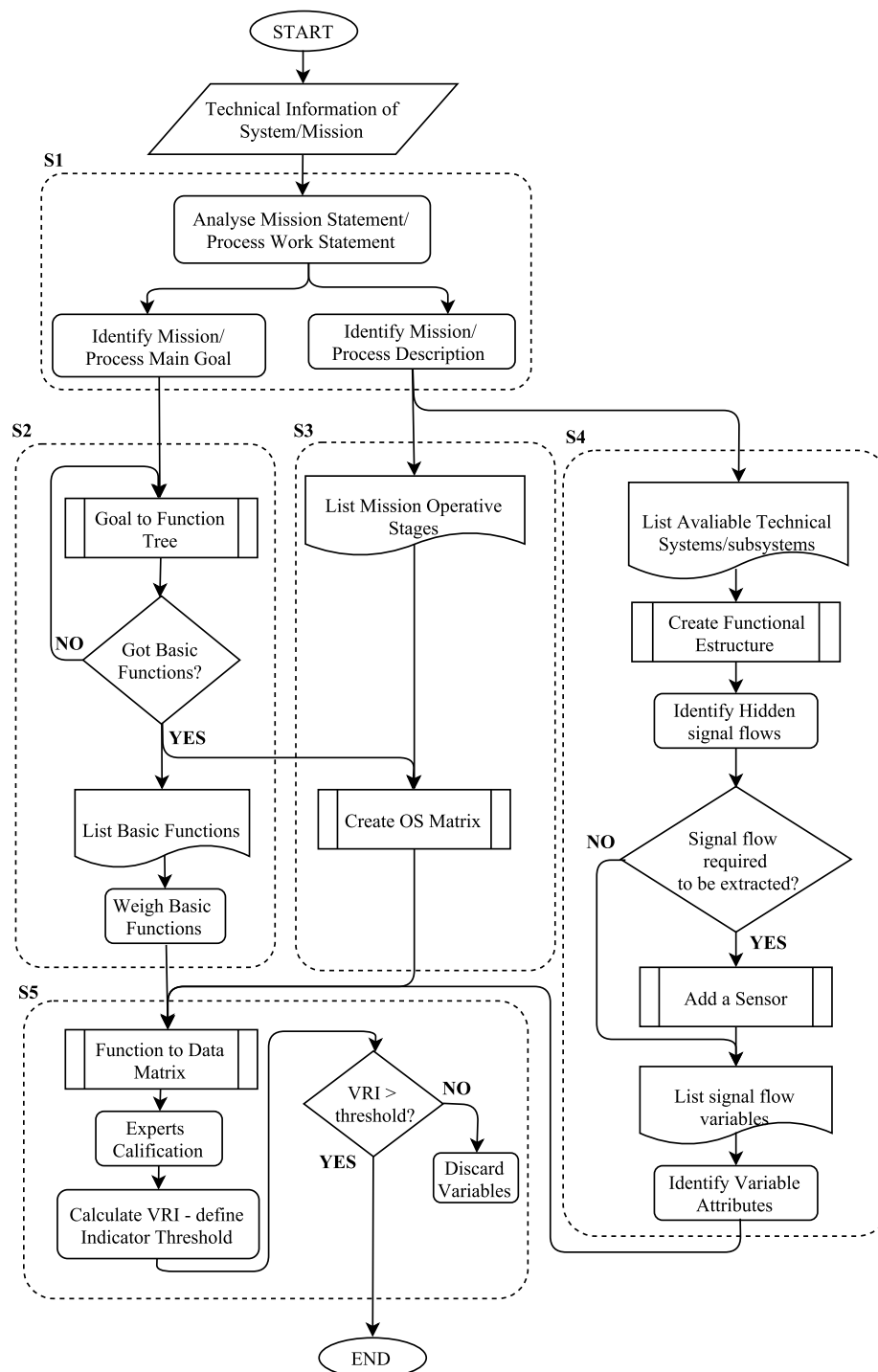

Figure 3.2: Complete scheme of Function to Data Matrix (FDM) approach applied to MC rooms

Up to this point of the proposal, both the basic functions and their relative weights, available

variables and their respective attributes have been obtained. Then, through the fifth stage, *Function to Data Matrix*, it is sought to Operators (who are the process experts) to relate both the basic functions of the system the available information from process expressed as variables. At the end, a weighting of the variables is obtained, and, can be used to determine which are the most relevant variables of the process, and its evolution through operational stages of the process. By selecting a variable threshold, then, the most relevant variables for the process can be selected to be used in HMI systems, prior to be used by Operators during process operations.

The detailed description of the method is shown in Fig. 3.2.

### **3.1 Step 1: Mission/Process Essential Analysis**

A mission is an assigned task in order to achieve any particular goal. The execution of this task depends not only on the entity or person who executes it but on different factors:

- The economic and technological resources available.
- The environmental conditions, the resources available and their restrictions.
- The time to execute the task and the expected results according to the objectives set.

All these guidelines are framed under the definitions of time, mode, and place. The tasks performed are usually supported by some type of technology or technical system, designed and constructed taking into account the constraints and resources available, in addition to qualified human personnel with the specific knowledge required for the execution of the tasks.

The term *mission* is normally used in the military field to express some type of operation that must be performed, whether combat missions to denote operations of attack or repulsion of the enemy, or missions of extraction to seek and protect members of the troop. Depending on the particular conditions of the task, the militia uses different technological resources: for example, when a bombardment of land positions is required, bombers are used. When a rapid deployment of troops on a terrain is usually required through a company of parachutists. On the other hand, if the threat is at sea, submarines or destroyers are deployed, as the case may be. Each of these teams has certain limitations and capabilities and is operated by personnel with specific knowledge that supports the tasks and ensures the success of the mission. In recent years, and with the improvement in air navigation systems, combat drones have been deployed flying hundreds of kilometers away from the Operator, who is on the ground and safe, controlling the device remotely.

### 3.1.1 Mission/Process Work Statement

A mission statement is a sentence where the purpose of carrying out an activity in concrete, its scope, available resources, as well as the expected results of the execution of the activity are set out in an explicit manner. Although the concept of mission definition can be related to the business environment and organization aims [Pearce and David, 1987], which specifies that it is related to the strategy that organization must have, and is usually delimited in time, a *mission* our context will end when the objectives are achieved or any constraint limits or blocks mission activities.

This statement revolves around the expected result of the execution of the activities, not being very specific when it comes to discriminating available resources, steps or methods, although if, defining the scope of what is wanted. Contains elements of Who, What, When, Where and Why but not specifically How [of Staff, 1979]. These elements are known as Mission Goals (MG). MG can be divided into smaller ones according to their scope, duration, number of activities, and operational stages.

The main characteristic of MG is that they can not be quantified or measured directly since they do not give explicit indications of how they are carried out or fulfilled, whether the expected result has been achieved or not. The way in which the performance of MG can be quantified is through the creation of quantitative indicators, which are defined as *Requirements* which are based on *Mission Objectives*. Clearly defined, decisive, but broad, attainable goals toward which every operation is directed [of Staff, 1979], mission requirements are measurable indicators that can be used to compare the expected performance of activities with the actual activities development. Then, to consider if activities were developed properly, *Success Criteria Indicators* can be used to determine if mission objectives are being fulfilled. *Secondary objectives* can also be defined depending on mission capabilities and constraints.

### 3.1.2 Mission/Process Description

The description refers to the breakdown of those elements of mode, time and place that frame the activities of the mission. In these terms, they are related to the detailed description of available technological and environmental resources, constraints, scheduled activities and time limits for the execution of the mission. For each type of mission, there are particular characteristics that make it different from others, but, previous experiences can give precious insights on how to proceed in the next mission; this are often called *programs*, which are a set of missions framed under the same

broad objectives (e.g. *Mercury* and *Gemini* programs were used to gain experience that served *Apollo* program execution). In general, the following factors should be assessed when dis-aggregating the mission description:

- **Functional:** mission tasks must be carried out in accordance with the guidelines established in the main and secondary objectives.
- **Operational:** mission tasks must be able to be developed under established schedules (time constraints related to natural or human defined events) deadlines, operational ranges, mission duration or even time constraints due to funds availability), with an established level of reliability and being able to perform the required tasks under the technological and environmental conditions of mission, following a schedule of operational stages (which describes possible operation steps required to accomplish mission goals, related to the basic analysis of mission and vehicle).
- **Constraints:** they can be budgetary depending on the costs of the mission (and policies or regulations according to the nature of the activities of the mission or the priorities of the owners of the mission or stakeholders), expected time defined by the stakeholders to achieve the proposed objectives. Environmental constraints in accordance with the natural conditions in which the mission activities will be developed. Technological aspects with respect to the technical development required for the execution of the mission tasks, as well as the knowledge, monitoring and control capacities through the HSC system[Larson and Wertz, 1992, Shishko and Aster, 1995].

In order to facilitate the understanding of the process of extracting information from the mission statement, the theoretical case presented by Larson and Wertz [Larson and Wertz, 1992] is used as an example in the "Space Mission Analysis and Design" book that presents the SMAD methodology for the analysis of aerospace missions, shown in the Appendix A. The authors hypothetically proposed the design of the *FireSat* mission, which is responsible for detecting and sending information about the formation of forest fires from space.

## 3.2 Step 2: Basic Functions Analysis

The *Mission Description* is denoted by context, required and available resources, tasks to be performed and timelines. The purpose of the mission task execution and its expected results can be defined as mission objectives and *Mission Goals*. Although they are set out qualitatively, they can

be measured in a quantitative way defining performance indicators or *Success Criteria Indicators*, showing the degree of compliance or failure of the tasks. To accomplish a task or a mission, certain technical functions must be completed in a specific order and in its entirety, which are accompanied with human activities or monitoring. They are related to operational capabilities, devices intended to convert energy, get data or process matter in a system.

For example, a commercial rocket launch activities start when the rocket is still in ground, in its launching pod. Refueling activities starts first, which requires the activation of fuel pumps and pressure regulation systems for the tanks to reach its maximum level and operating pressure. heating systems also prevents ice formation inside fuel pipes and valves. After the refueling process is complete, the pumps are turned off and valves are closed. During take off, engine propellant is pumped through turbo injection systems, then release valves starts working to allow the engine to reach its operational pressures and temperatures. Meanwhile, gyro-stabilized nozzle systems starts to correct rocket position as its losing mass and requires to follow a pre-planned trajectory codes, sent by the MC via Radiofrequency link. When rocket reach first stage operating ceiling and main fuel tanks are empty, locking devices operates and releases the first stage and all this systems, which lends the rocket to loose weight and continue its mission. As soon as the second stage reaches atmosphere limit, engines turn off and external trajectory correction systems starts to release high pressure shots of gas to re-orientate the vehicle into its required orbit. This short example shows how several technical systems works together for a rocket launch and orbit, and how each of this systems are required to ful-fill the main function of the rocket.

### 3.2.1 Goal to Function Tree GFT

Operational phases and device or process functions are directly related to the functional capabilities of the process. A way to find relationships between technical functions and mission based on mission objectives is to apply a functional tree analysis called Goal to Function Tree (GFT), proposed by Johnson [Johnson, 2013, Viscio et al., 2015], and which is a derivation of the Objective Tree Analysis from Pahl and Beitz [Pahl and Beitz, 2013]. A GFT can be used to identify required functions for accomplishment of a main goal. Required functions can be broken down into lower level functions, and should be expressed as a verb and noun being as general as possible. In lower levels of the tree, functions becomes simpler and gives detailed indications on how the higher level functions should be performed. If functions can not be broken down (without relating them directly into technical

solution concepts or design solutions) they're called *Basic Functions*, and they appear at the end of each *branch* of the tree. Going down the tree, the *how* of mission objectives are defined. Going up the tree, the *why* are defined [Johnson, 2013, Viscio et al., 2015]. Each end of branch is also called a *leaf*, as shown highlighted in Fig. 3.3.

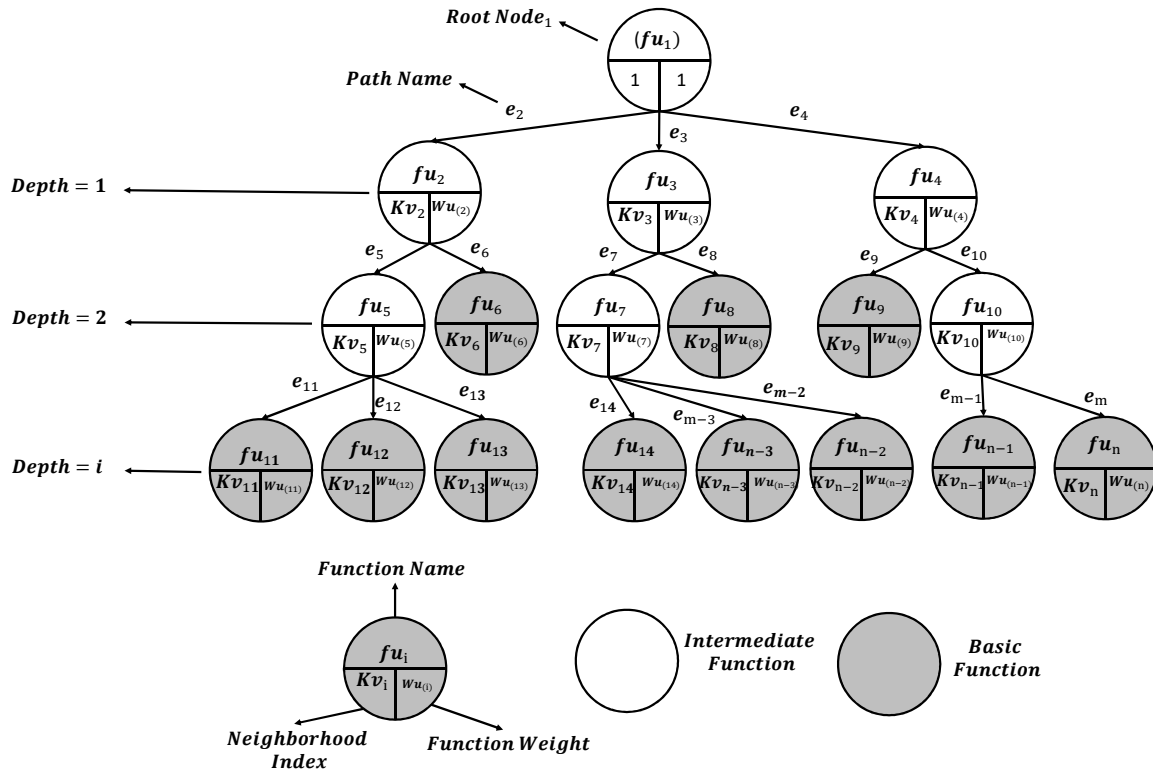

Figure 3.3: Goal to function tree Graph

The result from GFT, resembles a tree, often used in graph theory. Thereby, this tree can be converted into a numeric sequence for easy analysis through Prüfer Analysis for graphs, with the purpose of obtain a Prüfer sequence array, called  $S$ , useful to identify basic functions - *leaves* for each branch in the tree. this process is shown below.

### 3.2.2 Prüfer Sequence for Goal to Function Tree

A Prüfer sequence, is a mathematical sequence of natural numbers associated with a labeled tree. Proposed by German Mathematician Heinz Prüfer in 1918, as a result of proving Cayley's Formula [Chair of Combinatory Geometry, 2016]. Although Prüfer sequence can be obtained by successive iterations, for small labeled tree's can be applied doing simple calculations. By obtaining a Prüfer

sequence, A GFT can be labeled conveniently and represented by a vector  $S$  of natural numbers. Then, labels of *Basic Functions* can be calculated from  $S$  and  $L$  vector. The procedure is shown below.

for a given GFT diagram  $T$  with  $n$  labeled functions or vertices's which belongs to set  $L$  so that

$$L = (fu_1, fu_2, fu_3, \dots, fu_n), fu_n \in \mathbb{N} \tag{3.1}$$

Vertices's labels can be arranged as desired, ensuring there is not repeated element of  $L$ . This gives a number of spanning trees of  $n^{n-2}$ , which is named as Cayley's Formula. also, there is a unique sequence  $S$  which represents the labeled tree  $T$

$$S = (a_1, a_2, a_3, a_{n-2}), a_n \in \mathbb{N} \tag{3.2}$$

Known as Prüfer Sequence, or Prüfer code, with  $n - 2$  elements, according to Cayley's Formula. A Prüfer code for a GFT can be generated by iteratively removing vertex from the tree until only two vertex remains, and removing the leaf with the smallest label value  $fu_n$  and setting it to be the label of this leaf's neighbour on  $S$  sequence.

By using an example of a  $n$ -labeled random tree, a Prüfer Sequence can be obtained from a tree by following the next steps shown in Fig.3.4

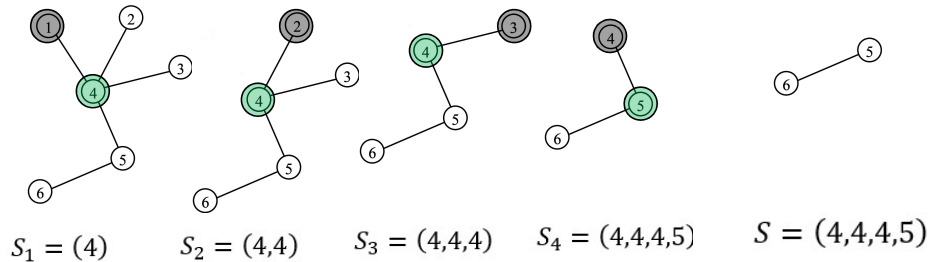

Figure 3.4: Function to Data Matrix construction from a mission statement analysis

The procedure is shown below:

1. Find the leaf with the smallest label and add to  $S$  the number of its neighbor
2. Delete this leaf, together with the only edge adjacent to it.
3. Repeat until only two vertex are left.

Lower level functions or *Basic functions* array  $Fu$  can be extracted from the GFT by observation, highlighting the leaf for each branch, or, from Prüfer Sequence analysis as is shown:

$$S \subset L; S, L \in \mathbb{N} \quad (3.3)$$

$$F_u = L - (S \cap L) \quad (3.4)$$

Also, starting from a Prüfer sequence  $S$ , a tree with  $n$  labeled vertex can be obtained by the following algorithm, shown in Fig.3.5

### Convert-Prüfer-to-Tree (L)

```

1 n ← length[a]
2 L ← a graph with n+2 isolated nodes, numbered 1 to n+2
3 degree ← an array of integers
4 for each node i in L
5   do degree[i] ← 1
6 for each value i in a
7   do degree[i] ← degree[i] + 1

```

Next, for each number in the sequence  $a[i]$ , find the first (lowest-numbered) node,  $j$ , with degree equal to 1, add the edge  $(j, a[i])$  to the tree, and decrement the degrees of  $j$  and  $a[i]$ . In pseudo-code:

```

8 for each value i in a
9   for each node j in L
10    if degree[j] = 1
11      then Insert edge[i, j] into L
12          degree[i] ← degree[i] - 1
13          degree[j] ← degree[j] - 1
14          break

```

At the end of this loop two nodes with degree 1 will remain (call them  $u, v$ ). Lastly, add the edge  $(u,v)$  to the tree.

```

14 u ← v ← 0
15 for each node i in L
16   if degree[i] = 1
17     then if u = 0
18           then u ← i
19           else v ← i
20           break
21 Insert edge[u, v] into L
22 degree[u] ← degree[u] - 1
23 degree[v] ← degree[v] - 1
24 return L

```

Figure 3.5: Algorithm to convert a Prüfer sequence into a tree[Chair of Combinatory Geometry, 2016]

### 3.2.3 Basic Function weighing

Each *Basic Function*  $f_u$  has a position relative to the others within GFT. With respect to its vertical position, as a function lays on a lower level of the tree, is considered a more disaggregated function. This means that its dependence on other functions at the same level is lower, and therefore, its contribution to the fulfillment of the main objective depends on the execution of other neighbor functions. In contrast, as a basic function is higher up in the tree hierarchy, its dependence on other functions is smaller and its degree of importance increases with respect to the fulfillment of the main objective by itself.

**Neighborhood index** The importance of the *Basic Functions* can also be analyzed taking into account its number of neighboring functions (Which are at the same level and belong to the same branch of the tree). As the number of neighboring functions increases, their relative importance decreases, based on tree hierarchy.

The importance of the basic function with respect to its neighbor functions can be analyzed through the neighborhood index, or  $K_v$ , which allows finding the neighborhood weight of the basic function with respect to the others at the same level and same tree branch. Since the hierarchical importance of the function decreases with the increase of the quantity of the neighboring functions, the neighborhood index of a basic function is defined by:

$$K_v = \frac{1}{Nn} \quad (3.5)$$

Being  $Nn$  the number of neighbor functions coming from the same tree branch. The higher the number of *Basic Functions*  $f_u$  the lower neighborhood index, and vice-versa. For example, a basic function with a  $K_v = 0.33$  neighborhood index has 3 neighbor functions. A  $K_v = 0.166$  corresponds to a function with 6 neighbors, and so on.

**Basic Function Weight** From graph theory, a path is the sequence of nodes and edges connecting a node with another descendant in a tree graph. As shown in the figure 3.3, the *Root Node*  $N_0$  is the one from which other nodes are detached. The depth of a node is determined by the number of edges between it and the root node, and the level at which a node is located is defined as the depth of that node +1. As shown in the previous section, from the definition of the Prüfer sequence it was found that the number of numbered nodes belonging to the set of basic functions  $F_u = L - (S \cap L)$  are called

leaves. Then, as a path runs from the root node  $N_0$  to another node (in this case a leaf), the path between the root node and leaf can be expressed as:

$$P(Fu_{(n)}, E) = [fu_{(n)} \in Level[i], fu \in Level[i-1], fu \in Level[i-2], \dots, fu_1 \in Level[1]] \quad (3.6)$$

$$Fu_n = L - (S \cap L) \quad (3.7)$$

$$E = [e_1, e_2, e_3, \dots, e_{m-1}, e_m] = S \quad (3.8)$$

$$S = (a_1, a_2, a_3, a_{n-2}), a_n \in \mathbb{N} \quad (3.9)$$

Then, since each basic function  $fu_i$  is also defined by a neighborhood index  $K_v$ , the weight of each basic function or  $Wu_i$  can be expressed as the multiplication of each of Neighborhood index values for each tree node, as follows:

$$Wu_{(n)} = [Kv_{(n)} \in Level[i] \times Kv_{(n)} \in Level[i-1] \times Kv_{(n)} \in Level[i-2] \times \dots \times Kv_{(1)} \in Level[1]] \quad (3.10)$$

From this analysis, the vector of weights for the basic functions of the system is defined as:

$$Wu = [Wu_{(1)}, Wu_{(2)}, Wu_{(3)}, \dots, Wu_{(n-2)}, Wu_{(n-1)}, Wu_{(n)}] \quad (3.11)$$

and must be fulfilled that:

$$\sum_{i=1}^n Wu_i = 1 \quad (3.12)$$

Each of the basic functions  $Fu_i$  has a participation in the fulfillment of the stated objective (main goal). It is established that when the basic functions are performed satisfactorily, the fulfillment of the main objective was achieved with a value of 1 (or 100% in terms of percentages).

### 3.3 Step 3: Operative Stages Analysis

The basic functions that were explored in the previous section depend not only on the fulfillment of the main objective. It can happen that depending on the expected result of a system, their interaction determines the result of the process and the required inputs and expected outputs of the systems. When

a certain number of functions are executed together and a given result is obtained, then a process task is performed. Generally, these tasks can have sequential behaviors (where the results - output flows are inputs to the next task). There may be parallel tasks. Having into account that the beginning and ending of a task is determined by execution times, and, is plausible to have a combination of tasks in execution. Each combinations of tasks can be considered as operational stage of the system.

From the point of view of the process or the mission, operational stages that are carried out at different times, even if the same technical procedures are executed, are required. From the point of view of the technical system, although the same tasks can be executed at different times, there is no differentiation in the way the system operates, so it can be considered that, for the process, the operational stages do not depend on when tasks are executed, but the final tasks sequence.

Usually, task are performed in a similar way is shown in the Fig. 3.6.

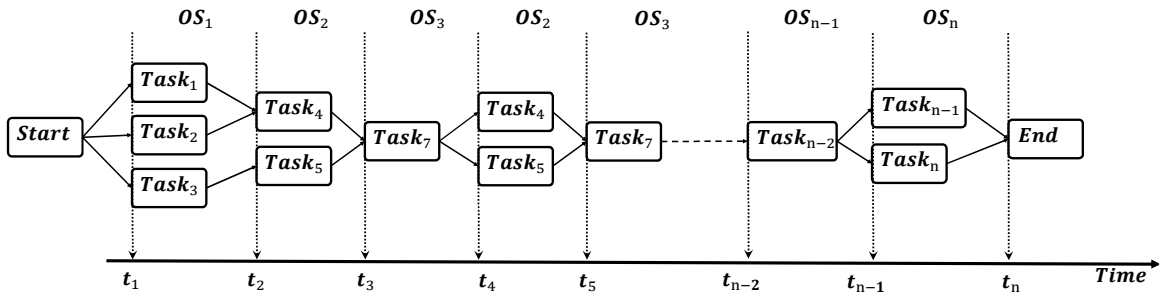

Figure 3.6: Operational stages general series-parallel tasks scheme

The execution of the functions for each operational stages depends on the particular requirements that exist for each task. As an example, during the take-off of an airplane, the function performed by the landing gear (suspend or roll) is performed until the take-off is performed. At the moment when the landing gear is retracted and the doors are closed, these functions are "switched off" or stopped until a landing stage is required again to activate the landing gear in a new operative stage. Based on the example, it could be said that the functions that are not in use become in a state of waiting or *IDLE*, which can be represented by a 0. The a zero value does not necessarily indicates this function disappears. If functions are not in a *IDLE* state, can be represented by a 1. This is the state of the function, or  $S_{fu_n}$ , shown as it follows:

$$S_{fu_n} = \begin{cases} 0 & IdleState \\ 1 & Operating \end{cases} \quad (3.13)$$

For each operative stage, a combination of n-function states  $S_{fu_n}$  exists. so, for an entire mission or process divided into time periods  $t_m$ , each of one corresponding to a operative stage, a function state vector or  $OS_{t_m}$  can be arranged as shown:

$$OS_{t_m} = [S_{fu_1}, S_{fu_2}, \dots, S_{fu_{n-1}}, S_{fu_n}] \quad (3.14)$$

The rows corresponds to the sequence of basic functions that are activated or remain on *IDLE* state for each time interval. The columns corresponds to all possible operating states of the process, for different time intervals:

$$OS_{[m,n]} = \begin{bmatrix} OS_{t_1} \\ OS_{t_2} \\ \dots \\ OS_{t_{m-1}} \\ OS_{t_m} \end{bmatrix} = \begin{bmatrix} S_{fu_1} & S_{fu_2} & \dots & S_{fu_{n-1}} & S_{fu_n} \\ S_{fu_1} & S_{fu_2} & \dots & S_{fu_{n-1}} & S_{fu_n} \\ \dots & \dots & \dots & \dots & \dots \\ S_{fu_1} & S_{fu_2} & \dots & S_{fu_{n-1}} & S_{fu_n} \\ S_{fu_1} & S_{fu_2} & \dots & S_{fu_{n-1}} & S_{fu_n} \end{bmatrix} \quad (3.15)$$

Then, if a function state vector is obtained for each operative stage, the array of mission operational stages can be arranged. From this matrix, can be established, that, there are same state vectors for different operative stages. This can be achieved by inspection or by converting each of the state vectors into their corresponding decimal value by considering the vector as a binary number. This can be achieved through the expression:

$$| OS_{t_m} | = \sum_{i=1}^n 2^{i-1} S_{fu_i} \quad (3.16)$$

After obtaining the value, could be found that there are two or more state vectors that have equal values. Then, the basic functions are the same, regardless of whether operation state they belong. This way, repeated operative modes can be found, simplifying the overall analysis. After performing the procedures of this section, two vectors are obtained, both the vector of weights of the basic functions  $W_n$  and operative stages state vector  $OS_{t_m}$  for each operative stage . These will be inputs for the weighting of the functions and analysis of the variables in the next section of this work.

## 3.4 Step 4: Functional Structure Analysis

A technical system refers to those mechanical, electrical, electronic, hydraulic, etc. components that were designed and built for specific purposes of transformation of matter or energy, and which together, are capable of fulfilling a certain task. Generally, these components use physical principles to perform these tasks. For example, a lever is able (with a suitable pivot), to perform a work. By having two levers joined to the same pivot, it is possible to take objects (in the same way as a pair of pliers). If more levers are added to this mechanism, it is possible to perform greater complexity tasks.

This also can be analyzed for other type of devices that rely on other physical principles. When looking at the system as a whole, the "overall function" can be identified by simple abstraction, but without being able to discern the state of those internal components. In simple systems such as pliers, when a force is applied in the tool handle, a greater force (reaction) appears at the tip of pliers, having enough mechanical energy to grip, or cut an object. In the case of more complex systems like a vehicle engine, it is harder to understand the process of converting fuel (chemical potential energy), to useful mechanical energy.

### 3.4.1 System Functional Structure

It is necessary to analyze the technical system from subsystems, as it is easier to understand how these transformations of energy and matter are made. This is a subject of research by some authors, such as (Pahl & Beitz)[Pahl and Beitz, 2013].

In other systems where technical relations transformation or conversion (and many others) of matter and energy, information flows appear that indicate the status of a subsystem to another, by signs of mechanical, electrical type, etc.

for example, in the case of pliers, when a force is applied on the handles, a reaction appears at the tips of the pliers as they touch the object. Then a sudden tightening force appears, causing the handles to stop. This stopping acts as a signal, indicating the user that the object has been secured. For this case, the "object has been secured" signal can be easily perceived by the user. In the case of a steering vehicle, as the steering wheel is turning, the user receives a feedback of centripetal acceleration (the apparent force out of the path of the vehicle), indicating the vehicle is turning down a corner, for example. When a coffee maker emits steam, or a sound from a running engine is perceived, or a failure signal is received from a bag sealing plant, these signals can easily be perceived by the user, which allows him to make inferences regarding the state of operation of the system, and make

decisions. In the case of pliers, when the user perceives the force reaction on the handle, he knows that the object has been secured. In the case of a combustion engine, the user by himself is not able to determine the exact amount of fuel in the tank without the aid of a fuel gauge. these signals enter and leave the technical system, since they are discernible.

But, there is the case of other types of signals that are hidden to the user, but exists among the subsystems. For the combustion engine example, the pressure of the oil pump, or the amount of air entering the engine is measured through sensors, that delivers the signals to the on-board computer of the vehicle, which modifies the quantity of fuel injected to the engine to maintain the mixture at an optimal point. This information is not visible to the user, who only realizes a problem at the moment of a system failure. This type of information is based on hidden signals, which travel between subsystems, but can not be seen by the user directly.

Beitz [Pahl and Beitz, 2013] then proposes the analysis of the interactions between the subsystems, through a Functional Diagram (FD) structure, shown in a general way in Fig. 3.7.

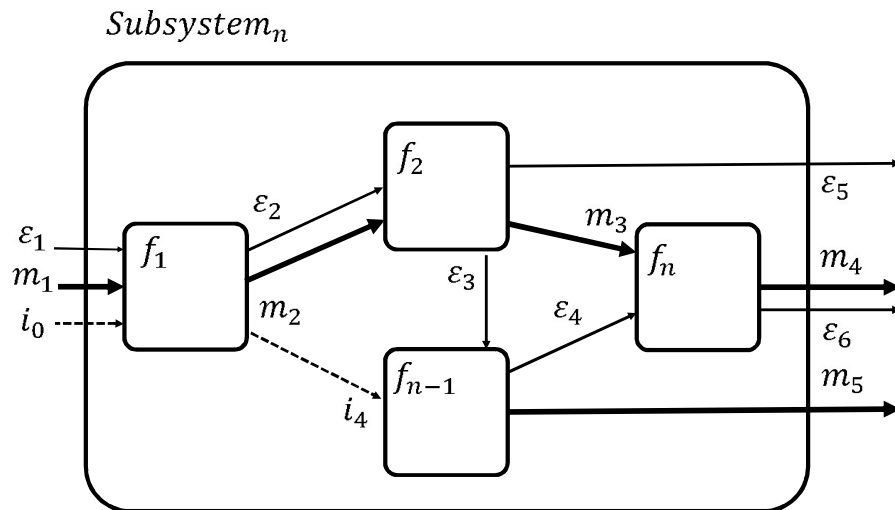

Figure 3.7: FD structure, with incoming and outgoing flows of energy, matter and signal [Pahl and Beitz, 2013]

When it comes to design a process, the analysis is performed through the definition of functions based and requirements. In case of analysis to existing systems, it must be performed the transformation of functional structures (through the definition of basic classes and functions) [Pahl and Beitz, 2013, Kirschman and Fadel, 1998]. Normally, the generation of the functional structure of the system is compatible with reverse engineering product analysis [Otto and Wood, Wood, 1997].

The result, clearly shows the interactions between the subsystems, represented in flows of matter, signal and energy.

### 3.4.2 Addition of Sensors

By themselves, the underlying information flows can be used as performance indicators for a particular subsystem by adding a function carrier block called *Sensor*. Although in practical terms a sensor is a device that interacts with the magnitude to be evaluated and that undergoes a change in response to this interaction, it may be considered a function carrier that extracts the information coming from a hidden signal flow, without modifying it.

According to the representation of the general basic functions proposed by Krumhauer [Krumhauer, 1974] a sensor is defined from the perspective of the functional structure as shown in Fig. 3.8.

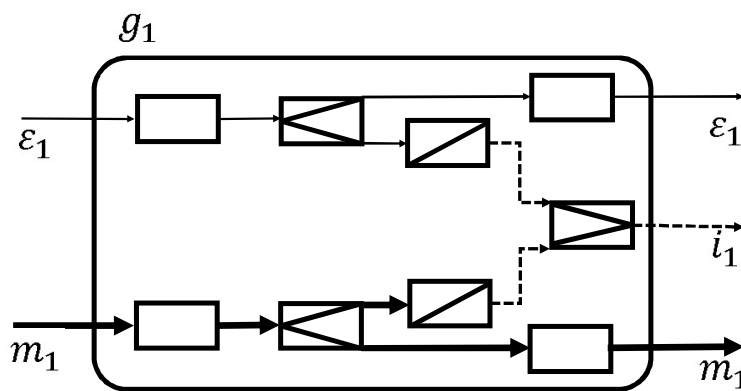

Figure 3.8: Theoretical function carrier block definition for a sensor

Theoretically, the inclusion of a sensor does not represent changes in the functionality of its dependent subsystem. However, sensors require the transformation of energy or matter to operate, and the signals it provides usually relies on a medium to be "sent", in other words: signal need certain amount of energy to be transmitted. Then, the inclusion of a sensor should not be done in an arbitrary way and must meet the following criteria:

1. **Feasibility:** in technical terms, feasibility defines if a sensor can be installed in process. This means that a energy supply is available for the sensor to operate, as well as the way of exposing the device to the magnitude to be measured. Is the case, for example, of the installation of an electronic pressure sensor in a entirely pneumatic system. For this case, its possible to replace the electrical supply of the sensor with a battery, but, there are more inconveniences to do so

instead of installing a Bourdon type pressure gauge. Although a Bourdon gauge has a lower resolution than a electronic gauge, a Bourdon is more appropriate due to system restrictions.

2. **Need:** A evaluation if a sensor is required or not, based on GFT and process objectives. Should be evaluated whether the desired variable can be measured indirectly (and then calculated), or, it should be measured directly. Be the case of a water heater. It is necessary to know the temperature of the water through a Thermopylae or semiconductor sensor?. Water heater requires of adjusting parameters by the user?. A Thermostat fulfills heater functions?. Its required to measure energy consumption?. it is required to install a energy meter device?.
3. **Degradation:** Since sensors are physical devices which requires certain energy (and sometimes, transforms matter) to work properly, it is possible that their installation impacts in an adverse way the operation of the technical system. For this, it is necessary to evaluate the benefits and the disadvantages of sensor installation; the possibility of using another device that has a lower impact or has a greater comparative advantage than others, justifying the readjustment of the technical system. Is the case of a *Pitot Tube*. Installed in the wings of an airplane, a Pitot can affect the plane airflow and therefore, modify the aerodynamic performance of the wings. Is also the case of a large weight topographic instrument, which increases power consumption of a drone, reducing flight times and making this setup impractical to perform certain tasks.

Then, the sensor output signals have to be included as a signal outcome of the system, as shown in Fig. 3.9.

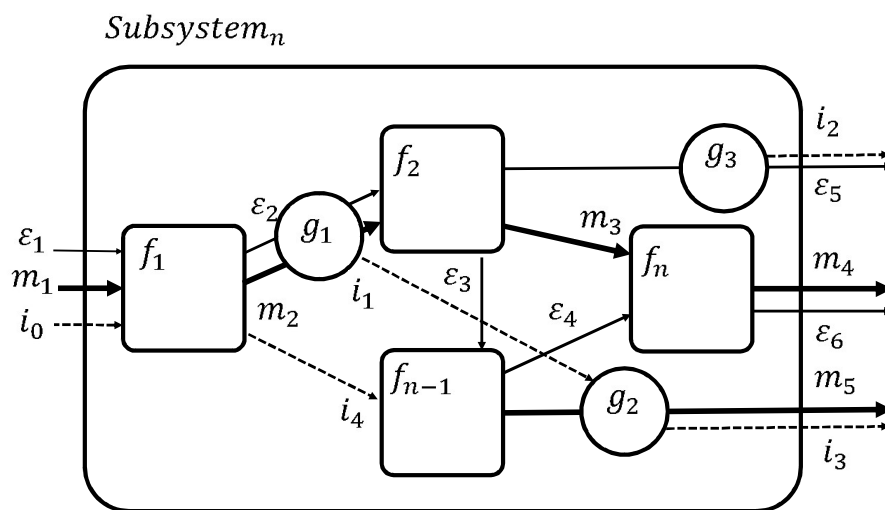

Figure 3.9: Theoretical Sensor Addition in a Functional structure.

### 3.4.3 Variable Attributes

Depending on the source of a variable, has certain characteristics related to the nature of the outgoing subsystem, and its specific functions. Although between process, variables can change its nature radically, there is a common classification, widely studied from the statistical analysis.

Initially, a variable can be *dependent* or *independent*. The dependent variables are those for which a response is expected after applying a treatment or some condition to the system. For example, the speed of a vehicle according to the position of the throttle pedal. As the pedal is pressed, the speed of the vehicle increases, and viceversa. Therefore, the speed of the vehicle depends on the position of the throttle pedal. Generally, the dependent variables are the response variables of the system (output variables), coming out from signal flows. In the case of the independent variables, they do not depend on any action that is performed on the system. Their variations depends on randomness, or, the action of external process. For example, wind speed, or ambient temperature.

Both dependent and independent variables can be measured, but only dependent variables can be controlled. It is important to identify which variables can be controlled as they become system input variables and their output will impact system functions. The independent variables, on the other hand, affects the process, but can not be affected, then, the Operators can only follow up and act in consequence, affecting some of the input variables. In the context of mission analysis, dependent variables will be considered *controllable variables*, and independent variables will be *observable variables*.

Then the type of information that the variable delivery can be analyzed. When the variable delivers numerical data on a continuous scale, it can be said to be a *continuous variable*. For example, the temperature measurement in a system that yields information in degrees Celsius is a continuous variable. On the other hand, if the variable data is delivered on a non-continuous numeric or alphanumeric scale, or varies according to certain "categories" of values, the variable is said to be *Categorical*. If these categories are ordered in a finite and integer numerical scale, the variable is said to be *Categorical Ordinal*. If categories can not be organized or are not based on a numerical scale, it is said that the variable is of *Nominal Categorical* type. If there are only two possible categories, that is, the variable is in a state of on or off, fail or OK, normal or danger, it is said that the variable is a *Categorical Dichotomous* type. Generally Nominal and Dichotomous Categorical variables respond to alarms or states of operation of a system. Ordinal categorical variables generally express input values of a system. The continuous variables can express the current state of a measured quantity,

and its variations in time, or with respect to other Continuous or Categorical variables [Gotelli et al., 1995].

**Variable classification**

Variables with similar characteristics can be grouped, receiving same treatment during processing and visualization. To ease the classification process, four basic classification parameters are defined:

- $\alpha$  (Alpha) or *Variable Type*. Alpha parameter can be assigned to a variable depending on its type. is represented by a pair of Characters  $X_1X_2$ , being the first digit  $X_1$ , defined by 0: continuous; if the variable is continuous, 1:nominal if the variable is nominal or ordinal, 2:dichotomous if variable has a binary output. In general, Alarms and Failure indicators are dichotomous variables. The second digit  $X_2$  is defined by 0: observable for an independent variable, 1: controllable for a dependent variable.
- $\beta$  (Beta) or *Magnitude*: The values that a variable can represent are encompassed under the successive measurement (through sensors) of a given physical phenomenon. Beta represents the magnitude of the variable under some accepted system of units, so that the nature of the data that is represented through the variable can be identified. For the case of variables of categorical type where the measurement of a magnitude can not be identified, but if a defined behavior or state, its value will be equal to zero.
- $\gamma$  (Gamma) or *Variable Range*: The range of values that can be taken to satisfy certain operating conditions that ensure the reliability of system operation is known as the operating range [Corporation, 2014]. This is defined by the operating limits (Low Alarm Limit - LAL and High Alarm Limit - HAL). The interval in which the process works safely and within its expected ranges is known as Acceptable Operating Interval - AOI. The range of values that system can take outside its operative limits, but surpassing equipment limitations, material resistance, temperature limit or power consumption is known as Safe Design Interval or SDI, which is delimited with Low Setpoint Limit or LSL and High Setpoint Limit or HSL, as shown in Fig. 3.10; both ranges defined by:

$$SDI = HAL - LAL \tag{3.17}$$

$$AOI = HSL - LSL \tag{3.18}$$

$$AOI \in SDI \tag{3.19}$$

Then it is expected that during the development of the mission activities, the variables will

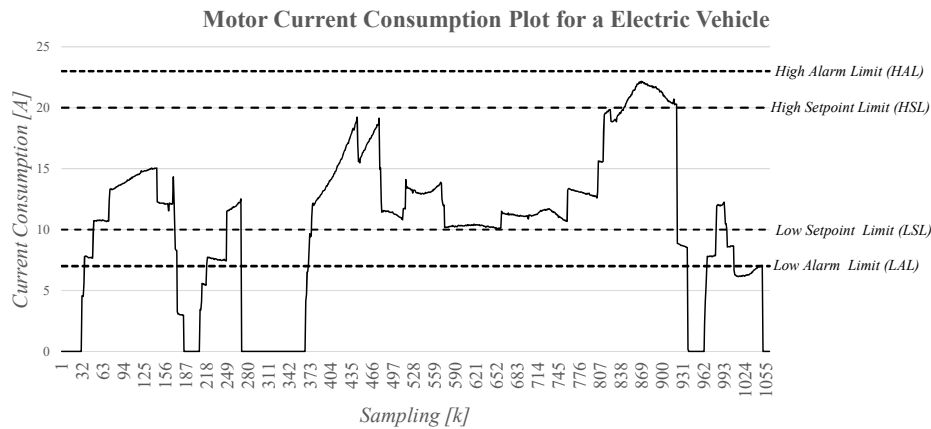

Figure 3.10: Graphic definition of Acceptable Operative Interval (AOI) and Safe Design Interval (SDI) for a process variable

remain within the values defined by AOI. In the moment that some variable leaves this range, the expected result of the activities can be affected, as well as the performance of the system. If the variables exceed the SDI range, the integrity of the subsystems that make up the process is compromised, and thus, the fulfillment of the mission objectives. In terms of operative and safe Intervals, a variable can be defined by the use of a membership function  $u(x)$  (shown in Fig. 3.11) which shows that for an specific mission or process definition, a certain variable belongs to it. As a variable starts to derive out from the Safe Design Interval, its membership function starts to approach zero. This means that corrective actions must be taken.

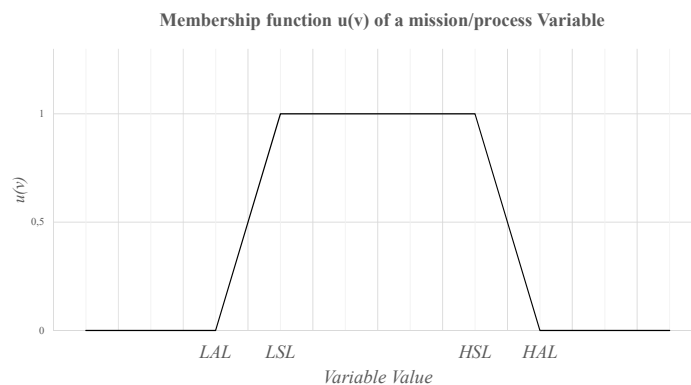

Figure 3.11: Membresy Function defined for a Mission Variable

The Gamma parameter for each variable is then defined as an arrangement of the maximum and minimum, acceptable and design limits of the system as:

$$\gamma = [MiAL \quad MiOL \quad MaOL \quad MaAL] \quad (3.20)$$

$$u(x) = \begin{cases} 0 & (x < a) \text{ or } (x > d) \\ \frac{x-LAL}{LSL-LAL} & LAL \leq x \leq LSL \\ 1 & LSL \leq x \leq HSL \\ \frac{HAL-x}{HAL-HSL} & HSL \leq x \leq HAL \end{cases} \quad (3.21)$$

- $\delta$  (Delta) denotes *Sampling Frequency*. The sampling frequency determines the most appropriate rate at which a signal of a variable must be retrieved, so that its evolution can be fully identified. Usually the sampling rate of the signals present in a process (or technical system) are not the same, since they depend on how they recover the variables. For example, speed measurement on a wheel returns a large volume of samples because speed variations occur in very small times. On the other hand, when monitoring the temperature, it depends on the thermal inertia of the system, which varies very slowly. If a reconstruction of the behavior of the system is required, some variables will change at different rates than other, for each time instant. Then, the sampling frequency of the variables must be taken into account. This frequency is represented in Hertz (*Hz*). Then, there are signals that do not respond to specific sampling frequencies, but are variables that may respond asynchronously (as alarms do, although they are signals that are sampled at defined intervals, usually present asynchronous changes), with  $\delta$  values of zero.

In this way, for each of the variables identified in the system, there is an arrangement with its characteristics as shown in Expression 3.22:

$$V_i = [\alpha, \beta, \gamma, \delta] \quad (3.22)$$

$$V_i = [X_1 X_2, (PhysicalMagnitude), [MiAL, MiOL, MaOL, MaAL], Hz] \quad (3.23)$$

### 3.5 Step 5: Function to Data Matrix

So far, in the previous steps, the elements summarized below have been identified.

From step 1 (Mission / Process Essential Analysis) shown in Section 3.1, a mission objective was found. Basic functions were broken down using the Goal to Function Tree (GFT) Tool. From these functions, in step 2 (Basic Functions Analysis) shown in Section 3.2 The basic functions of the system were identified using graphs theory and their relative weights of the were obtained, thus arranging the vector of weights of these functions as it follows:

$$Wu = [Wu_{(1)}, Wu_{(2)}, Wu_{(3)}, \dots, Wu_{(n-2)}, Wu_{(n-1)}, Wu_{(n)}] \quad (3.24)$$

In step 3 (Operative Stages Analysis) shown in Section 3.3, the operational states of the mission were defined, indicating whether the basic functions are required or not for each operational stage, expressed through a matrix of binary numbers as follows:

$$OS_{[m,n]} = \begin{bmatrix} OS_{t_1} \\ OS_{t_2} \\ \dots \\ OS_{t_{m-1}} \\ OS_{t_m} \end{bmatrix} = \begin{bmatrix} S_{fu_1} & S_{fu_2} & \dots & S_{fu_{n-1}} & S_{fu_n} \\ S_{fu_1} & S_{fu_2} & \dots & S_{fu_{n-1}} & S_{fu_n} \\ \dots & \dots & \dots & \dots & \dots \\ S_{fu_1} & S_{fu_2} & \dots & S_{fu_{n-1}} & S_{fu_n} \\ S_{fu_1} & S_{fu_2} & \dots & S_{fu_{n-1}} & S_{fu_n} \end{bmatrix} \quad (3.25)$$

Finally, in step 4, (Functional Structure Analysis) in Section 3.1, the process variables were analyzed analyzing their components, as well as evaluating the relevance of including variables that are not measured in the process. For each of the variables, the type of variable was also analyzed, obtaining for each one an attribute array:

$$V_i = [\alpha, \beta, \gamma, \delta] \quad (3.26)$$

$$(3.27)$$

Then this information is used as input for the construction of the data function matrix as shown below.

### 3.5.1 Function to Data Matrix

The simplified structure of the Function to Data Matrix is shown in Table 3.1.

Table 3.1: Simplified Structure of Function to Data Matrix Analysis for HSC systems

Flow Variable	Attributes				Basic Functions								V.Rel.
	$\alpha$	$\beta$	$\gamma$	$\delta$	$f_{u1}$	$f_{u2}$	$f_{u3}$	$f_{u4}$	$\dots$	$f_{u_{n-2}}$	$f_{u_{n-1}}$	$f_{u_n}$	
				$OS'$	$S_{fu1}$	$S_{fu2}$	$S_{fu3}$	$S_{fu4}$	$\dots$	$S_{fu_{n-2}}$	$S_{fu_{n-1}}$	$S_{fu_n}$	$P_{vi}$
$f_1 \sim f_2 v_1$	$\alpha_1$	$\beta_1$	$\gamma_1$	$\delta_1$	$k_{f_1 v_1}$	$k_{f_2 v_1}$	$k_{f_3 v_1}$	$k_{f_4 v_1}$	$\dots$	$k_{f_{n-2} v_1}$	$k_{f_{n-1} v_1}$	$k_{f_n v_1}$	$P_{v_1}$
$f_1 \sim f_2 v_2$	$\alpha_2$	$\beta_2$	$\gamma_2$	$\delta_2$	$k_{f_1 v_2}$	$k_{f_2 v_2}$	$k_{f_3 v_2}$	$k_{f_4 v_2}$	$\dots$	$k_{f_{n-2} v_2}$	$k_{f_{n-1} v_2}$	$k_{f_n v_2}$	$P_{v_2}$
$f_1 \sim f_2 v_3$	$\alpha_3$	$\beta_3$	$\gamma_3$	$\delta_3$	$k_{f_1 v_3}$	$k_{f_2 v_3}$	$k_{f_3 v_3}$	$k_{f_4 v_3}$	$\dots$	$k_{f_{n-2} v_3}$	$k_{f_{n-1} v_3}$	$k_{f_n v_3}$	$P_{v_3}$
									$\dots$				
$f_1 \sim f_2 v_{i-2}$	$\alpha_{i-2}$	$\beta_{i-2}$	$\gamma_{i-2}$	$\delta_{i-2}$	$k_{f_1 v_{i-2}}$	$k_{f_2 v_{i-2}}$	$k_{f_3 v_{i-2}}$	$k_{f_4 v_{i-2}}$	$\dots$	$k_{f_{n-2} v_{i-2}}$	$k_{f_{n-1} v_{i-2}}$	$k_{f_n v_{i-2}}$	$P_{v_{i-2}}$
$f_1 \sim f_2 v_{i-1}$	$\alpha_{i-1}$	$\beta_{i-1}$	$\gamma_{i-1}$	$\delta_{i-1}$	$k_{f_1 v_{i-1}}$	$k_{f_2 v_{i-1}}$	$k_{f_3 v_{i-1}}$	$k_{f_4 v_{i-1}}$	$\dots$	$k_{f_{n-2} v_{i-1}}$	$k_{f_{n-1} v_{i-1}}$	$k_{f_n v_{i-1}}$	$P_{v_{i-1}}$
$f_1 \sim f_2 v_i$	$\alpha_i$	$\beta_i$	$\gamma_i$	$\delta_i$	$k_{f_1 v_i}$	$k_{f_2 v_i}$	$k_{f_3 v_i}$	$k_{f_4 v_i}$	$\dots$	$k_{f_{n-2} v_i}$	$k_{f_{n-1} v_i}$	$k_{f_n v_i}$	$P_{v_i}$

The **Flow** Column ( $v_i$ ) indicates the incoming and outgoing signal flows from where variable was obtained, based on FD analysis. For each flow, the variables are listed. It is recommended to include the name of the variable (in the variable column) for easily recognition.

Next, the variable attribute vector is included in the **Attributes** column. This information will be useful to Operator for determine the nature of the variable during Score. Variable attribute vector it is also important when grouping the different variables according to their common characteristics to ease HMI Design.

**Basic Function** Columns, or Basic Functions  $f_{u_n}$ . There will be as many columns of basic functions as basic functions were obtained. for each  $f_{u_n}$  column, will be a implicit basic function weight and operative stage value. Column  $P_{fj}$ , indicates the result of the analysis expressed as the Function Relevance Indicator, or VRI. There will be as much  $P_{fj}$  as variables have been extracted from the process.

### 3.5.2 Experts Score

As was pointed out during the contextualization of this work, the knowledge concerning the operation of a process comes from the Operators, who makes decisions according to their specific circumstances and allow to keep the process within the expected parameters. Then, and as it was done by some other proposals evaluated previously, it is necessary to involve them in the design process of telemetry and data deployment systems. With FDM, it is sought that the Operators have visibility of the process from two points of view:

1. The expected functions of the process, from the definition of its objectives.
2. The variables coming from the process. Knowing its origin (signal flows), its attributes (characteristics, operating limits within the parameters of the process and maximum limits).

The Score of experts is based on looking for relationships between the functions that the system must perform within process limits and its technical characteristics expressed through FD.

Generally, these relationships were made based on the intuition and the experience of the Operators, especially when the process has been operating from the past. In order to standardize the way a variable is related to a function in FDM, the use of a relation indicator is proposed, which assigns numeric values to categorical values. This value is known as a Variable Relationship Descriptor (VRD) expressed in FDM as  $kf_jv_i$ , which indicates the value  $K$  of a basic function  $f_j$  with respect to a variable  $V_i$ , as shown below:

$$kf_jv_i = \begin{cases} 0, & \text{null} \\ 1, & \text{weak} \\ 3, & \text{medium} \\ 9, & \text{strong} \end{cases}$$

VRD can take 4 possible values. For  $kf_jv_i = 0$  or *NULL*, there is no relationship between a certain variable with a function within process context. For example, for a given basic function *To control the temperature of the product* in liquid tanks, and measured variable *Rotational speed of the pump motor* is being evaluated. It is likely that the water temperature changes with the change in pump speed, but in the process, neither the function nor the variable are related, so it is assigned a value of  $kf_jv_i = 0$ .

In the opposite case, there are variables that have a strong relationship with the functions within process. Then, in this case, a value of  $kf_jv_i = 9$  or *STRONG* is assigned. In this case, and taking as reference the example above, a strong relationship to the variable *rotational speed of the pump motor* can be assigned to a basic function *fill the tank* since they have a causal relationship, because the pump is responsible for carrying liquid to the tank.

For intermediate cases, VRD takes values of  $kf_jv_i = 1$  for *WEAK* relationships and  $kf_jv_i = 3$  for *MEDIUM* relationships. Generally weak or medium relationships appear when there are parallel subsystems that affect the performance of the process in a different manner.

For example, when evaluating the variable *Volume* in a Bluetooth speaker, where one of the basic functions is *To store energy*, can have a direct relationship because, the higher volume, the higher

power consumption, and therefore less autonomy. There are other variables that also affect the storage energy function, such as the start-up time. For this case, although there is a direct relationship, it is not so strong, so it is scored with intermediate values.

After performing the score for each possible  $kf_jv_i$ , the calculation of VRI, expressed as  $P_{fj}$  in the equation 3.28, can be done as:

$$P_{fj} = \frac{1}{9} \sum_{j=1}^n kf_jv_i S_{fu_j} W_{u(j)} \quad (3.28)$$

Where  $kf_jv_i$  is VRD,  $S_{fu_j}$  is the operating state of the function for an operating state,  $W_{u(j)}$  Is the weight of the basic function. It should be noted that for a given operating state certain basic functions may take values of  $S_{fu_j} = 0$  which cancels the weight value of this basic function, eliminating the effects of this basic function for a given operational stage..

The output value of  $P_{fj}$  is normalized and depends directly on the number of basic functions. This value is the same for each variable, then, VRI is a relative indicator, and with other process contexts, different values of VRI could be obtained.

VRI also depends on the values of each function for each operating state. Then, since there is more than one operating state in the process a FDM analysis should be performed for each operational state. (Fig. 3.12) in each case the operating state vector affects the VRI in a different way and therefore, there are different values of VRI for each variable and each operating state. There will be operating states where the VRI of a variable is higher or lower. That implies that for each operational state of the process, there will be variables that will be more relevant than others.

At the end of the analysis,an arrangement of VRI values of  $n$  operative states and  $i$  variables is generated (like shown in Eq. 3.29, where the evolution of the relative relevance of the variables is evidenced.

$$\begin{bmatrix} FDM_{OS'_1} \\ FDM_{OS'_2} \\ \dots \\ FDM_{OS'_{n-1}} \\ FDM_{OS'_n} \end{bmatrix} = \begin{bmatrix} P_{fj}(v_1, OS'_1) & P_{fj}(v_2, OS'_1) & \dots & P_{fj}(v_{i-1}, OS'_1) & P_{fj}(v_i, OS'_1) \\ P_{fj}(v_1, OS'_2) & P_{fj}(v_2, OS'_2) & \dots & P_{fj}(v_{i-1}, OS'_2) & P_{fj}(v_i, OS'_2) \\ \dots & \dots & \dots & \dots & \dots \\ P_{fj}(v_1, OS'_{n-1}) & P_{fj}(v_2, OS'_{n-1}) & \dots & P_{fj}(v_{i-1}, OS'_{n-1}) & P_{fj}(v_i, OS'_{n-1}) \\ P_{fj}(v_1, OS'_n) & P_{fj}(v_2, OS'_n) & \dots & P_{fj}(v_{i-1}, OS'_n) & P_{fj}(v_i, OS'_n) \end{bmatrix} \quad (3.29)$$

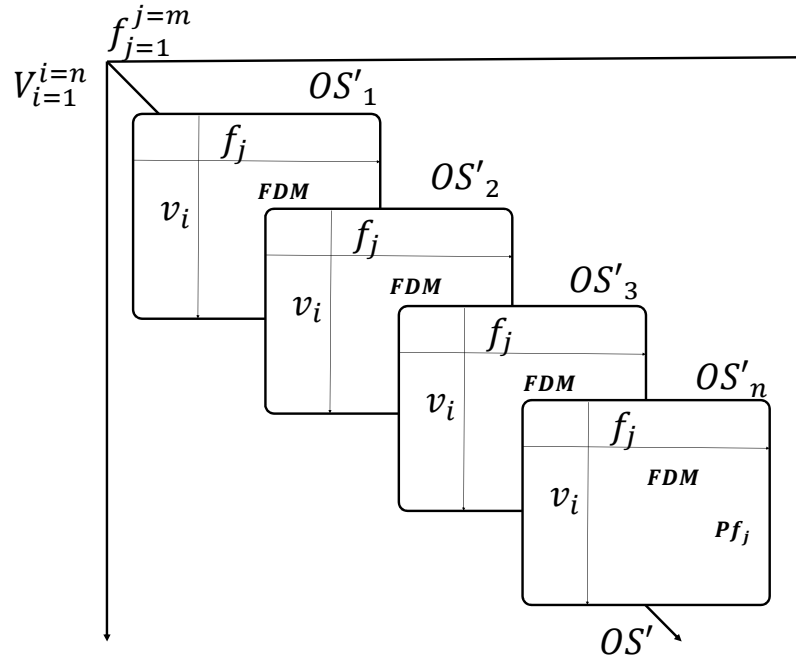

Figure 3.12: FDM evolution due to changing operative stages

### 3.5.3 Variable Relevance Indicator Threshold

A VRI is assigned to each variable  $v_i$ , for each operative state. The VRI vector for each variable describes the relative weight of the variables. When comparing these vectors, the relative weights of the variables will be different since they depend on different operating states. It is likely that, depending on the order in which the variables  $v_i$  have been analyzed, no clear patterns can be identified in said vectors, so that, by rearranging the variables for each vector by its value of VRI, a trend can be found.

Although decisions can be made regarding the importance of variables with respect to their trend, it is suggested the application of a threshold value, which determines whether a variable should or should not be taken into account for the process. The threshold value is expressed as follows in equation 3.30

$$Th_{OS'_i} = \max [P_{f_j}(OS'_i)] (1 - K_{Th}) \quad (3.30)$$

Whereby the threshold value  $Th_{OS'_i}$  for the operating state  $OS'_i$  depends on the maximum value of the VRI for said operating state, and also depends on the threshold adjustment value  $K_{Th}$ . Threshold

adjustment value takes values between 0 and 1. The larger the value of  $K_{Th}$ , the smaller the value of  $Th_{OS'_i}$ , and, the number of Variables whose VRI values are included by the threshold will be greater. For example, when a threshold adjustment value of  $K_{Th} = 0.3$  is selected, variables whose VRI are within the upper 30%, are included by the threshold value. Instead, the remaining 70% will be excluded.

Then, for each operating state, there will be a value of  $Th_{OS'_i}$ . A threshold for each operating state, can be defined by Eq.3.31

$$\begin{bmatrix} FDM_{OS'_1} \\ FDM_{OS'_2} \\ \dots \\ FDM_{OS'_{n-1}} \\ FDM_{OS'_n} \end{bmatrix} = \begin{bmatrix} Th_{OS'_1} \\ Th_{OS'_2} \\ \dots \\ Th_{OS'_{n-1}} \\ Th_{OS'_n} \end{bmatrix} \quad (3.31)$$

Then, the system variables will be valid for each operational state if it is satisfied that the VRI value for the variable is greater or equal to the threshold value, accordingly to Equation 3.32:

$$P_{fj}(v_i, OS'_i) = \begin{cases} 0, & P_{fj}(v_i, OS'_i) < Th_{OS'_i} \\ P_{fj}(v_i, OS'_i), & P_{fj}(v_i, OS'_i) \geq Th_{OS'_i} \end{cases} \quad (3.32)$$

At the end, each variable will have as many VRI values as operative states  $OS'_n$ , having zero values in case VRI has not exceeded the threshold value  $Th_{OS'_i}$ . This indicates that the variable is not relevant for said operative state).

Now, the result will be a list of variables with their respective VRI. A high value of VRI indicates a high relevance of the variable for said operating state, while a lower value indicates a lower relevance. Taking into account such values of relevance, can be used to decide to include or not this variable in the monitoring systems, not only by including it in the HMI systems, but deciding, using methods of ergonomic design of interfaces, The most appropriate way of deploying it according to its relative relevance and critically.

## Chapter 4

# Case Study: Solar Electric Vehicle (SEV)

## Racing

This project is framed under the redesign and optimization of a solar vehicle of competition for the *World Solar Challenge 2015* in Australia, a race between the cities of Darwin and Adelaide. The project was developed jointly with public companies of Medellín, and succeeded to the project "Design and construction of a solar vehicle to participate in the world solar challenge 2013". From the experiences of the first competition, and in order to improve the race results for the second competition, the proposed method was applied as shown below. As a contextualization, a small account is made of the definitions of the race and the vehicle. In addition, the application of the method, as well as its results, is explored step by step.

### 4.1 Racing Electric Solar Vehicles

A Solar Vehicle is an electric vehicle that takes advantage of the energy coming from the sun through a photovoltaic array, delivering it to an electric motor for its locomotion. Part of the energy, and according to the power consumption of the vehicle, is stored in a battery. A simplified scheme of a Solar Electric Vehicle is shown in Fig.4.1. Because these vehicles can store and convert limited amounts of energy from the Sun (due to inefficiencies in the devices, low solar panel generation and restricted energy storage capacity in batteries), they are designed optimizing both the mechanical systems and the electronic devices.

From mechanics, weight is reduced by using lightweight materials such as aluminum or titanium,

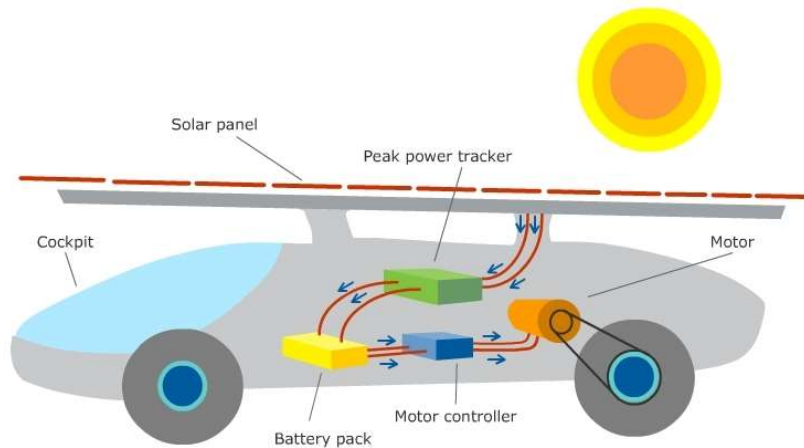

Figure 4.1: Solar Electric Vehicle Simplified scheme [Science Learning Hub - The University of Waikato, 2010]

iterating its design, accompanied with Finite Element Analysis (FEA). From the aerodynamics, it is sought to reduce to the maximum the losses of energy by aerodynamic drag by covering the wheels and avoiding entrances of air to the vehicle cockpit.

From electrical and electronic systems, the solar panel temperature should be reduced as much as possible, in addition of using maximum power point trackers or MPPTs to maximize the power from the cells. The energy density of the battery (or its capacity to store energy per kilogram of weight), is maximized by selecting high-performance cells and using Battery Management Systems or BMS. It seeks to reduce losses in the drive wheel eliminating the mechanical transmission through the use of a *Brushless Hub Electric Motor*. Both motor and speed controller are optimized to reduce power losses by copper or Eddy parasitic currents.

These developments involve a great investment of time and money. As each vehicle is manufactured following strict regulations for competition, they are relegated to research applications or competition due to the efficiency and costs of the components, being far to be utilitarian vehicles. In terms of research, they serve as platforms for the development of electronic components, aerodynamic design, development of light materials, special fabrications, etc. This has generated interest in accelerating the development of these technologies through universities around the world.

### 4.1.1 World Solar Challenge

The World Solar Challenge, known as Bridgestone World Solar Challenge (BWSC) since 2013, was the first competition of its kind in the world, led by researcher Hans Tholstrup with the construction of the first solar vehicle, "The Quiet Achiever", which in 1982 Crossed from West to East of the Australian continent, covering a distance of about 4000km between the cities of Perth and Sydney, in a 23 days journey[Snooks, 2015]. The event, which is currently being held every two years, seeks university teams from around the world to travel a distance of 3000km between the cities of Darwin (in the Northern Territories) and Adelaide, in the South Australia. Race roadmap is shown in Fig. 4.2 [Shimizu et al., 1998].



Figure 4.2: Bridgestone World Solar Challenge 2015 Roadmap [South Australian Tourism Commission - The Motor Sport Group., 2017]

Competition takes place across the continent on an interstate highway (the Stuart Highway), under normal driving conditions and open to normal traffic, which includes high-speed combustion vehicles, as well as over sized and heavy-duty trucks known as road trains. This forces the teams to accompany

the solar vehicle with other vehicles of combustion as an escort. Within the route, there is an average of 2 control stops per day, where the organizer of the event can adjust the partial race positions, as well as allowing the teams to perform a short 30-minute energy recharge, where vehicles can recover between 300Wh and 500Wh.

At the end of each race day, between 5 pm and 8 am, the teams are bound to stop, recover some of the energy before dusk and dawn, as well as perform maintenance and repair of the vehicle, without modify or recharge the battery. (Fig.4.3)

On average, a competition team can run daily on this scheme between 500km-650km, which allows it to reach Adelaide in a lapse of 5 to 6 days. At the end, the team's official time (measured between 8 AM and 5 PM, including control stop times), is added up. The team that has the lowest race time becomes the winner.



Figure 4.3: Primavera 2 Solar Vehicle Cruising in Stuart Highway and charging process during 30 minute mandatory control-stop

#### 4.1.2 Vehicle Design and Optimization

The Bridgestone World Solar Challenge is an endurance race, where it must be controlled certain variables that allow the vehicle to increase both its autonomy and its average speed [McCarthy et al., 2000]. For this race, not necessarily conventional racing pilots are the most suitable to pilot solar vehicles, due to their style of driving which aims to reduce average power consumption per kilometer. Although these vehicles can reach speeds of up to 120km/h, the competition does not constitute a maximum speed test. It requires a thorough analysis on the conditions of design and construction of

vehicle. This analysis determines the parameters of the vehicle.

The conditions of competition, which include variables such as the available radiation from sun, wind conditions, road slope, roughness of the asphalt, position of the sun and time of day, etc. influence the performance of the vehicle. Then, simulations of vehicle are carried out before the race, and its speed, power generation, and energy consumption are evaluated through optimization algorithms in order to maintain the highest possible speed at the lowest possible energy consumption.

The optimization algorithm uses historical information, but also must be loaded with real information from the competition. This requires constant monitoring of the variables involved, including critical systems that keeps the vehicle running all time during the race. The long distances and the conditions of the race forces the Racing team to process the incoming information from the vehicle in real time. Part of the received data is loaded into the optimization algorithm so that the optimum speed of the vehicle can be recalculated in run-time. At the end of the day, historical data can be used to make decisions and determine the race strategy for the next day. In a certain way, the operation of receiving information and calculating the optimum speed of the vehicle responds to the operations carried out in a HSC system.

## 4.2 Case Study: Racing Solar Electric Vehicle *Primavera2*

*Primavera2* is the name of the second Solar Challenger class (from the International Solarcar Federation - ISF) (Fig. 4.4) built in Colombia by engineers and students from different disciplines (mainly from Product Design Engineering at EAFIT University and other Universities), under the leadership of the Design Engineering Research Group - GRID and Empresas Públicas de Medellín - EPM. The design, which took about a year, ended with a construction phase of 4 months, and the subsequent shipment to Australia. With a test period of about 2000km before the competition (combining local and foreign tests in Northern Australia), and 3022 km solar race, *Primavera2* (Fig.4.4) is the solar vehicle with the best Colombian participation in a competition of this nature, reaching the ninth position of the general classification.

The project *Primavera2-Improvement of the design of the Primavera1 solar vehicle to meet more efficient guidelines for the World Solar Challenge (WSC) 2015*, sought, in addition to improving the position obtained by the solar vehicle *Primavera1* (thirteen of 30 teams) in 2013, to lead a optimization in the different subsystems, as well as in the administrative and planning processes of logistics and equipment, during the construction of the vehicle and during the competition in Australia. From

the point of view of engineering, for this new vehicle was sought to improve the relationship between the energy captured and the energy consumed (net efficiency increase). This was achieved, on the one hand, through an improvement of the strategy, and, on the other hand, with the reduction of weight, the aerodynamic drag force and the rolling coefficient.



Figure 4.4: Primavera 2 Solar Vehicle tests in Aeroparque Juan Pablo II Racetrack in Medellín

The objectives that were proposed for the project were the following:

**Primavera2 Project General Objective** Design and build a competitive solar vehicle, based on the experience gained in the *Primavera1* project, in order to develop technical improvements that allow to comply with the new guidelines of the WSC 2015 race that aim at a vehicle of greater efficiency in the use and energy generation.

#### **Primavera2 Specific Objectives**

- To incorporate *Primavera1* project learning's into the new working group, both at a technical and logistical level.
- To explore the selection and reduction of weight in components and the use of new materials, forms and manufacturing processes, in order to reduce the energy consumption associated with the rolling of the vehicle and the aerodynamic drag force with respect to *Primavera1* vehicle.
- To redesign the arrangement of solar cells and concentrators and the structure of the solar panel implemented in the vehicle of *Primavera1*, in order to increase the overall harvesting of solar

energy, through the exploration of new processes of lamination and the selection of materials and components.

- To identify and implement strategies and elements of innovation that are considered a competitive advantage for participation in BWSC 2015.
- To establish a vehicle design that complies with regulations established by the BWSC 2015 organizing committee.
- To perform technical tests on the vehicle, both static and dynamic, as well as the simulation of race conditions of BWSC 2015 in Colombia.

From the above information, the implementation of the method for the MCC of *Primavera 2* solar vehicle is performed, as described in Chap.3 and shown below.

To perform the analysis and method steps, relevant information was gathered from the competition regulations and vehicle design sheets. The Operators team (Known in the field of solar racing vehicles as Strategy Team), is composed by:

- Strategy Leader: (*Mechanical Engineer, MSc. in computational mechanics*) Strategy leader process the information coming from the solar EV and other sources (local forecast, road and race status, solar radiation, etc) as supply for a speed optimization model. This model should command Solar EV speed to run as fast as possible, reducing power consumption.
- Incoming energy managers: (*Electronic Engineer and Mechanical Engineer, MSc. in Engineering*). They are the experts in installations of Photovoltaic Energy.

Incoming energy managers receives information from main solar array and CPV (Concentration Photovoltaic Cells) sub modules. Based on the performance, alarms and actual status from MPPTS and cells, and estimates any damage or malfunction of the system. If necessary, Strategy leader can make decisions based on solar array readings, if the desired speed can not be reached under adverse conditions without draining unnecessary battery energy.

- Outgoing Power Managers: (*Mechatronics Engineer, MSc. In Engineering, and Electronic Engineer*). Experts in power electronics and battery design. Outgoing Power Managers receives information from battery array subsystems, logic electronics and telemetry RF systems and motor and speed controller subsystem. Based on the performance, alarms and actual status from BMS and cells predicts any damage or malfunction of the system.
- Mechanical Engineers: (*Mechanical Engineer, and Product Design Engineer*). Designers of the steering system and vehicle suspension. In charge of finding possible mechanical system

failures using driver information through the radio link, as well as performing the repairs that the vehicle needs.

The strategy team, was responsible for developing the steps of the method during the design and construction of the vehicle. The information was compiled through files on *Microsoft Excel*, complemented with the information provided by the competition reports of the *Primavera 1* vehicle (previously built by the research group for Bridgestone World Solar Challenge 2013).

#### **4.2.1 Step 1: Mission/Process Essential Analysis**

The Mission Essentials Analysis is based on the information obtained from the World Solar Challenge 2017 regulations and the technical information and career reports presented to EPM and the EAFIT University in 2015. Mission Top-End requirement table is shown in Table 4.1

##### **4.2.1.1 Mission/Process Work Statement**

Taken textually from World Solar Challenge website, the mission statement is as it follows:

*In friendly competition with others attempting the same goals, the teams depart Darwin aiming to be the first to arrive in Adelaide, some 3000km to the south. It's all about energy management! Based on the original notion that a 1000W car would complete the journey in 50 hours, solar cars are allowed a nominal 5kW hours of stored energy, which is 10% of that theoretical figure. All other energy must come from the sun or be recovered from the kinetic energy of the vehicle. These are arguably the most efficient electric vehicles. Having made the journey to Darwin by successfully navigating quarantine, customs, scrutineering, safety inspections and undertaken event briefings, participants are ready to start their epic journey. Once the teams have left Darwin they must travel as far as they can until 5pm in the afternoon where they make camp in the desert where-ever they happen to be. All teams must be fully self-sufficient and for all concerned it is a great adventure - many say the adventure of a lifetime. The Challenger class is conducted in a single stage from Darwin to Adelaide.[South Australian Tourism Commission - The Motor Sport Group., 2015]*

From the Mission Statement, can be inferred that:

1. The objective of the competition is to complete the route between the two cities (Darwin - Adelaide) taking advantage of the energy captured only from the sun, through Solar Electric Vehicle (SEV) Photovoltaic array.
2. The vehicle can not be controlled remotely, it must be driven by a pilot, complying with the

Table 4.1: Top-Level Mission Requirements for *Bridgestone World Solar Challenge 2015* and *Primavera II* Solar Vehicle.

TOP LEVEL MISSION REQUIREMENTS		
MISSION NAME	<i>Bridgestone World Solar Challenge 2015</i>	
<b>Mission Statement</b>	<i>In friendly competition with others attempting the same goals, the teams depart Darwin aiming to be the first to arrive in Adelaide, some 3000km to the south. It's all about energy management! Based on the original notion that a 1000W car would complete the journey in 50 hours, solar cars are allowed a nominal 5kW hours of stored energy, which is 10% of that theoretical figure. All other energy must come from the sun or be recovered from the kinetic energy of the vehicle. These are arguably the most efficient electric vehicles. Having made the journey to Darwin by successfully navigating quarantine, customs, scrutineering, safety inspections and undertaken event briefings, participants are ready to start their epic journey. Once the teams have left Darwin they must travel as far as they can until 5pm in the afternoon where they make camp in the desert where-ever they happen to be. All teams must be fully self-sufficient and for all concerned it is a great adventure - many say the adventure of a lifetime. The Challenger class is conducted in a single stage from Darwin to Adelaide.</i>	
<b>Mission Primary Objectives</b>	<i>To transport a driver from Darwin to Adelaide in a Solar Electric Vehicle taking into account all restrictions and conditions stated in the WSC Event Regulations Document (as complementary Mission Description)</i>	
<b>Mission Secondary Objectives</b>	<ol style="list-style-type: none"> <li><i>Incorporate Primavera1 project learnings into the new working group, both at a technical and logistical level.</i></li> <li><i>To explore the selection and reduction of weight in components and the use of new materials, forms and manufacturing processes, in order to reduce the energy consumption associated with the rolling of the vehicle and the aerodynamic drag force with respect to Primavera1 vehicle.</i></li> <li><i>To redesign the arrangement of solar cells and concentrators and the structure of the solar panel implemented in the vehicle of Primavera1, in order to increase the level of capture of solar energy, through the exploration of new processes of lamination and the selection of materials And components.</i></li> <li><i>Identify and implement strategies and elements of innovation that are considered a competitive advantage for participation in BWSC 2015.</i></li> <li><i>Establish a vehicle design that complies with regulations established by the BWSC 2015 organizing committee.</i></li> <li><i>Perform technical tests on the vehicle, both static and dynamic, as well as the simulation of race conditions of BWSC 2015 in Colombia.</i></li> </ol>	
REQUIREMENT	FACTORS	MISSION VALUES (GOALS)
		<b>FUNCTIONAL</b>
Performance	Primary Objective, Vehicle power consumption and cruise speed, solar array generation	Less than 2Kw power consumption, mean cruise speed of 100km/h, array generation over 1kWh
Mileage	Average distance count per day	Not less than 500km/day
		<b>OPERATIONAL</b>
Mission Duration	Experiment or operations	Mission operational at least 6 days and testing time (two weeks in Australia , 1 month in Colombia)
Availability	Level of redundancy	98% excluding weather, 3-day maximum outage
Survivability	Mechanics, Bodywork, Electronics during testing - shipping - racing stages	From initial testing to race finish - 5 months.
Data Link	Communication architecture and sampling period	Radio Link with 19 miles plain sight, ~600m running coverage, 1s sampling period and Redundancy
Vehicle preparation and operational tage change	Time of Vehicle preparation	<8 minutes average from vehicle stop to run.
		<b>CONSTRAINTS</b>
	Testing time	2-3 months
	Shipping and handling time	3 months
		Katherine (Opens 18/10/2015/11:10, Closes 18/10/2015/15:30), Dunmarra(Opens 18/10/2015/14:00, Closes 19/10/2015/15:00), Tennat Creek (Opens 19/10/2015/09:00, Closes 20/10/2015/14:00),Barrow Creek (Opens 19/10/2015/10:00, Closes 20/10/2015/16:00),Alice Springs(Open 19/10/2015/15:00-17:10,Open 20/10/2015/08:00-17:10,Open 21/10/2015/08:00-14:00),Kulguera (Opens 20/10/2015/08:30, Closes 22/10/2015/09:30),Coobber Pedy (Opens 20/10/2015/13:00, Closes 23/10/2015/11:20),Glendambo (Opens 20/10/2015/16:00, Closes 23/10/2015/14:00),Port Augusta (Opens 21/10/2015/10:00, Closes 24/10/2015/11:00)
	Race time limit	50 Hours
Environmental	Available solar radiation, Cross winds, Road Slop	700W/m2 mean radiation, ~10 knots cross winds, -5% to 5% mean road slope
Tecnological and interfaces	Access to top-end technology, Deployment of PC-Based telemetry interfaces, data sampling rate, latency	Human Factors & expertise in developing solar vehicles, expertise in graphical interface design, Strategist expertise, race ogistics experience, road navigation experience, learning curve of newcomers
Budget	Vehicle construction materials, veicle manufacturing, vehicle shipping, logistics budget (lodging and food)	\$US 1.1M
Regulations /Political	Vehicle Roadworthiness and transit regulation, importation and legalization process	Successfull scruteneering aproval, Maximum road speed of 100km/h (South Australia) 130km/h (Northern Territories), importation and vehicle legalization.

safety and ergonomic regulations established by the regulations and Australian roadworthiness vehicle conditions and laws.

3. During race, The vehicle is subject to all restrictions specified in the competition regulations, as well as those imposed by environmental changes (road gradient, wind, and sunshine, etc.).
4. The vehicle can only run within the official competition schedule, which is from 8:00 AM to 5:00 PM (Darwin Time - Solar Time).
5. A deadline of 50 hours is established to complete the race which defines time limits to arrive at control stops. Otherwise, the contestant fails and is forced to tow the vehicle to the city of Adelaide.
6. The competition is made in a single stage, for the Challenger-Class vehicles.

Then, the main objective of the competition, besides testing the technologies and engineering developments of the participating teams is to *Transport a Driver from Darwin to Adelaide in a Solar Electric Vehicle* taking into account all restrictions and conditions stated in the WSC Event Regulations Document (as complementary Mission Description).

**Success Criteria** Success Criteria is measured by time it takes to cross the finish line, with a reference maximum time limit of 50 hours. Competition does not define whether a team is successful or not, since they define it as a "Challenge against the Australian Outback" rather than as a conventional race. In order to control the travel of the teams are defined windows of time that the team must reach before being eliminated from the competition. Although the 10 best times reach a classification in the table of positions, the Success Criteria of the Competition are defined as it follows:

1. Depart from city of Darwin and arrive to the city of Adelaide within maximum established time deadlines, no trailering.
2. Arrive to city of Adelaide as fast as possible, within ten first teams.
3. Arrive to city of Adelaide in a safe way for pilot and support team.

#### **4.2.1.2 Mission/Process Description**

The race proposed by the World Solar Challenge, consists of a 3022km journey from the city of Darwin, in the Northern Territories of Australia, through the center of Australia, on the Stuart Highway, ending in the city of Port Augusta, in South of Australia, and from there to Adelaide, where the race finishes. After clapping in dynamic scrutineering (where pilot and vehicle technical skills are tested to circumvent different road conditions), and static scrutineering (which evaluates the suitability of

design and construction of the vehicle which needs to be legally driven on Australian roads), the vehicle can be formed at the starting line of the competition, according to the results obtained in a pole position test at the race track of Hidden Valley in Darwin. The basic stages of competition are described below:

**Competition Day** The organizers allow the battery pack of the vehicle to be charged at the start of the race, so the only source of energy available to the vehicle is energy recovered by the photovoltaic array. During the first few minutes of the race, and as the vehicle gains speed and drains some of the battery power, it operates with the solar array turned off, in order to prevent the battery from overcharging. As the vehicle moves away from the city center, and increases its speed, the strategy team decides when it is necessary to turn on the solar panel of the vehicle. The SEV is escorted by a convoy of conventional vehicles (shown in Fig. 4.5.) for control and protection purposes.



Figure 4.5: Primavera 2 Convoy scheme for World Solar Challenge 2015 competition

The regulations require at least 2 extra vehicles: the front vehicle located at a distance of 300m to 500m from the SEV, which is also known as LEAD, has the following functions:

- To protect the front of the solar vehicle from out-of-competition vehicles that may invade the solar vehicle lane
- To inform about the state of the road so that the solar vehicle can avoid hollows, dead animals, and bumps that could affect the stability of the solar vehicle and cause an accident.
- To establish the route of the solar vehicle, as soon as it should enter and leave the highway when approaching a control stop, or when it is required to stop for recharging and camping. In this vehicle, the navigating officer is in charge of reviewing the milestones of the road map and

checking at the route possible stop sites that have basic sanitary services, water, food, fuel, etc.

- To deal with emergencies with the solar vehicle, or mechanical or body faults that must be attended to due to accidents or fatigue of the components, and which may interfere with the running of the vehicle.

Behind the SEV, at a distance between 50m and 200m, is the CHASE vehicle, which is responsible for the following functions:

- To protect the rear of the SEV from out-of-competition vehicles that want to overtake or invade the solar vehicle lane.
- To receive the information via telemetry link of the solar vehicle, to store, to calculate according to the algorithms of strategy the optimum speed and to give details on the actions of conduction to the pilot. The CHASE is the only vehicle that has radio contact with the SEV so that the pilot only receives precise instructions on the driving mode of the SEV.
- To calculate the estimated position according to the mileage traveled, based on the race strategy calculations.
- To deal with emergencies with the solar vehicle, electronic failures of solar panel power, motor or battery. Because the CHASE vehicle is closer than the others during the race, the safety officers of the race are in it (both safety for the pilot and safety for the electrical system, in a case of a fire).

In addition to these two vehicles, the organization requires that a trailer or platform for SEV to be towed in case it can not move by its own power, either because it has no remaining charge or because it has a failure. The team has an additional vehicle called TRAILER, which is located behind the basic convoy at a distance between 500m and 800m, and has the following functions:

- To tow the platform or trailer that the team must have in case of a fault with the SEV
- Due to its load capacity, TRAILER must carry additional logistic elements such as camping and kitchen equipment, bags and tool.

Depending on the resources available, the equipment may have additional vehicles. The SCOUT and SUPPORT vehicles are responsible for the following tasks:

- To travel back and forth from the caravan, looking for fuel or food supplies.
- To provide logistical assistance to TRAILER vehicles and convoy if necessary
- To perform intelligence activities on other teams that are ahead and behind the convoy. This, in order to recalculate the strategy (and therefore the speed of the vehicle) as necessary.

As soon as the team convoy approaches a control stop site, both TRAILER, SCOUT and SUPPORT are separated from the convoy and preparatory activities are carried out for entry to the Stop Control.

**Mandatory Control Stops** The control stops are mandatory stops defined by the organization during the race, designed to control the position of competitors and ensure safety as the competition develops. In total, the organization has defined 9 mandatory stops at intervals between 4 and 6 hours apart, which implies that on average, a solar vehicle should make between 1.5 and 2 stops per day. The duration of the stops is 30 minutes counted from the moment the vehicle stops. During the stop control period, the vehicle can continue to use the solar panel to charge the battery. In technical terms, the vehicle is in standby or IDLE, so the engine does not turn on, but the solar panel generates energy that is stored in the battery. The stop control is divided into three stages. 4.6



Figure 4.6: *Primavera2* Control Stop Activities.

1. **Preparing the entry to Stop Control.** At the proper moment, SCOUT, is the vehicle in charge of coordinating the stops prior to the arrival of the convoy (with a minimum of 10 minutes). The staff of SCOUT is responsible for marking the entrance to the control stop site with cones and flags and to ensure sighting from the convoy. Find an optimum location (free of obstacles, stones, sharp objects or light obstructions), deploy a protective mat, as well as accommodate the ground personnel with the logic elements to clean the vehicle and cool of the solar array
2. **Arrival of the convoy.** When the convoy arrives at the chosen site, LEAD and CHASE leave the SEV, which is led towards the stop site. LEAD and CHASE refuel while the SCOUT team is responsible for the deployment of the solar panel, as well as to remove the pilot, provide hydration, and control the temperature and power generation of the solar panel. The choreography of vehicles is controlled by ground crew and organization personnel.

3. **SEV In position.** The vehicle is positioned and adjusted according to the position of the sun so that the amount of energy collected in the battery can be maximized. In addition, the panel cooling tasks are performed using a water atomizer, and the vehicle is cleaned.
4. **SEV Exit from the Control Stop.** Both the LEAD and CHASE personnel are ready to board the Convoy's vehicles, while the solar vehicle is closed down, the air intakes are sealed with tape. The pilot re-enters the vehicle and prepares to start. The technical check of the vehicle's systems, as well as the radio link and telemetry, are carried out. The SCOUT staff is responsible for delivering the vehicle back to the convoy, which complies with the 30 minutes regulation, part of the stop control under the LEAD indications. From this moment the vehicle leaves the Idle state and activates the engine.
5. **After the departure of the convoy.** staff of SCOUT and TRAILER is responsible for collecting the elements of the stop control, and leave.

**End of competition day** The competition schedule is from 8:00 AM to 5:00 PM (Darwin time, Solar time). In order to ensure a safe stop, the organizer allows a period of 10 minutes after 5:00 PM in which the convoy can find a safe place to stop. There is no preference for a camping detention site, both the strategist and team leaders should be responsible for selecting a suitable site that has basic health services, food or fuel, although the race team must be prepared to set up a camp in the moment that it is necessary, anyplace. When it is determined at a stop site, the stop is notified to SCOUT, which moves to the site and performs preparatory tasks to stop the vehicle, similar to how a stop is performed. After an appropriate demarcation of the place, the convoy moves to the stop site, where the SEV stops and deploys in the same way as in a stop control. The amount of energy available in the evening is much lower than the harvested during earlier control stops, so the equipment decides (depending on the state of charge of the battery and the indications of the strategist) Deploying the second concentration array photovoltaic array. The vehicle is in an IDLE state, so the energy that is collected in the solar panel is stored in the battery. Because there are no time controls, the vehicle is deployed until the net energy collected is equal or less than instantaneous energy consumption (around  $30Wh$ ), at which point the battery cuts off. At this time, the vehicle goes to OFF state.

As part of the competition regulations, the observer is responsible for confiscating the battery by placing it in a locked safety container, so that the battery can not be charged with chargers or power plants, or partially or totally replaced in case of any fault. At this time, the vehicle is ready to perform maintenance tasks such as cleaning, changing bearings or wheels, arranging damage to the

vehicle, etc. This process is carried out in parallel with logistical tasks such as camp assembly, food preparation and readjustment and evaluation of the day of competition.

Finished the day's tasks, the vehicle is closed and protected with protective blankets and the staff is ready to rest.

**Start of day of competition** The average day of competition begins at 4:00 AM, where the team wakes up and prepares to prepare the vehicle for the day of competition. By the geographical conditions of the Stuart Highway, it begins to obtain direct rays of the sun more or less after the 6:00 AM Darwin hour. The equipment then has 2 hours to prepare the vehicle, as well as reinstall the battery and position the solar panel.

Part of the team (mainly CHASE personnel, who are in charge of the electrical monitoring of the SEV, are responsible for preparing and starting the vehicle and testing the telemetry link. By putting it in the IDLE state), and the solar panel is connected as a preventive measure, insulating blankets are used to raise the temperature of the battery cells (seeking to improve the load efficiency). To pick up the camp, prepare food and get ready to leave. After about two hours of loading, the vehicle is set aside to leave the camp-site, under the same conditions of exit of the stop control, with the SCOUT staff in charge of The ground operations, again, both SCOUT and TRAILER are responsible for collecting the logistic material, the convoy departs at 8:00 AM (and in case of having arrived the previous day after 5:00 PM), a time penalty at departure, equivalent to the delay on arrival. The observer of the competition is in charge of restarting the stopwatch and the vehicle is set in motion along with the convoy.

Competition Day, stop-start and camp-in and camp-out activities are repeated sequentially until the vehicle arrives in the city of Adelaide, South Australia. On average, a team can carry out between 4 and 5 camp stops, 9 mandatory stops to stop, and around 10 deployments and folds of the vehicle, 4 or 5 changes of tyres and all other required activities.

## **4.2.2 Step 2: Basic Functions Analysis**

### **4.2.2.1 Goal to Function Tree GFT**

From the previous information, the Goal to Function Tree is arranged by the Strategy Team. For the case study, the following basic functions were identified, which are described below, justified from the regulations defined for the 2017 world solar challenge. From the objective of the competition,

which is  $f_{u1}$ : *To Transport a Driver from Darwin to Adelaide in a Solar-EV*, the following functions are broken down:

**To keep the Driver Alive** - As a construction standard, competition requires that vehicles be constructed to protect the driver in the best possible way in the event of overturning or collision, as follows:

**To maintain Structural Integrity** - The components of the vehicle must not enter the driver cabin (Regulation 2.4.1). In addition, the pilot should be seated in a normal handling position in the cockpit that protects him from a crash (similar to a 1m free fall into a concrete floor) (Regulation 2.4.2). The construction must comply with section *LK* of the National Code of Practice for Light In addition, during race conditions, and to ensure that the vehicle is kept in motion on the road, the vehicle's mechanical systems must perform reliably. The vehicle must be proven to be roadworthy. (regulation 2.23.1).

**To Provide Life Support** - It should be ensured that the pilot can keep his body temperature and hydration conditions (Regulation 2.5.1) because the pilot can be under temperatures of up to 55 degrees inside the vehicle. In addition, the rules on safe construction help keep the pilot alive in the event of an accident, as explained in the previous section. Some *UNECE* standards have been used in the World Solar challenge regulations concerning pilot safety. The movement of the head from the seat (UNECE Regulations 17 and 25). The position of the pilot's ankles should be lower than the position of the hip (regulation 2.7.5). The safety belts must be able to be adjusted with the pilot in the operating position and must comply with UNECE Regulation 16 or US FMVSS 571.209 (Regulation 2.7.6). The steering column must be designed to collapse in the event of a collision so that it does not impact the driver or affect him (Regulation 2.10.6).

In terms of vehicle operation, any cruise control function must be deactivated when the brake pedal is operated or the vehicle is switched off (Regulation 2.16.1). All components classified as high voltage (above 60VDC) must be protected by covers or grids that prevent the entry of fingers or objects above 1mm in diameter (regulations 2.19.1 and 2.19.2). The vehicle must also have a mechanism that carries it in a safe state, that is to say, where the risk of fire or electric shock is minimized for the pilot, occupants, team members, staff, or attendants (Regulation 2.20.1).

**To Transport a Driver** - The competition requires that the vehicles be manned with at least one pilot, who is in charge of operating it. The nature of the solar vehicles also requires responsible management of the energy consumed, as well as collecting energy in the following way:

**To Collect Energy** - The vehicle must be able to recover energy during the race, as follows:

**To Recover Kinetic Energy** - The vehicle can be provided with a regenerative braking system, which allows it to recover some of the energy consumed during braking situations, although, the regenerative brake is not considered as a braking system *per se*, under regulation 2.9.1

**To Collect Energy from the Sun** - The only external source of energy allowed for vehicles is that radiated directly from the sun. (Regulation 2.21.1). For challenger class vehicles, the allowed area of installed photovoltaic cells is 6.0 square meters for silicon-based cells (regulation 2.21.6).

**To Store Energy** - From the regulation (2.22.9), for Challenger Class vehicles, if the primary battery system is a secondary battery cells type (ie rechargeable cells), the sum of the nominal masses of the cells can not exceed the following limits:

- Li-ion 20,000 kg
- Li-Polymer 20,000 kg
- LiFePO4 40,000 kg
- Ni-MH 70,000 kg
- Pb-Acid 125,000 kg.

**To Manage Energy Consumption** - The only systems that consume energy in the vehicle are the motor and speed controller (which propels the vehicle) and the auxiliary systems that are required to power the battery, the telemetry systems, the power circuitry of the solar panel, turning light and horn, mandatory systems in the vehicle.

**To control Vehicle Speed** - The speed of the vehicle is directly controlled by the pilot, increasing or reducing the motor current set point. The pilot does not have the autonomy to increase or reduce this adjustment, which must be calculated from the CHASE vehicle, and the pilot is informed via the radio link.

**To Perform Driving Actions** - From the design of the vehicle, and for the pilot to be able to drive it, it is required that it has plenty of line of sight, and some device that allows visualizing certain blind areas of back of the vehicle, while in the driving position. (Regulation 2.6.2) (UNECE Regulation 46, Section 15). These systems may be electronic or mirrors. The windows of the vehicle must be made of impact resistant material and must not distort the vision or color of objects outside the vehicle with a minimum transmittance of 75% (Regulation 2.6.4 and Regulation 2.6.5 )

The braking systems of the vehicle must comply with UNECE Regulation 13-H and must be composed of two independent mechanical systems so that if one of them fails the other remains

operative. (Regulation 2.9.1). When braking, the vehicle must not overturn (Regulation 2.9.5)

The steering system must not have clearances or play, allowing the pilot to have maximum control at all times (regulation 2.10.1), and this, it should allow the solar vehicle to make a U-turn with a maximum diameter of 16m.

**To Send Vehicle Data to Crew** - The transmission of information from the vehicle to the CHASE team is carried out in two ways: through a two-way CB radio link, with a frequency defined by the organization (Regulation 3.7.1), and a data link (unregulated), allowing to transmit the telemetry information that requires CHASE to calculate the speed of the vehicle. A second private voice link is optional.

As part of the control of the race position, a tracking device and data logger, which is autonomous and provided by the organization, must be installed on each solar vehicle. (Regulation 3.20.1)

**To Calculate Speed SetPoint** - CHASE is the vehicle in charge of calculating vehicle speed based on telemetry information, current race position, and information provided by the rider (related to the mechanical condition of the vehicle). In order to secure the correct operation of the vehicle, the vehicle speed value, which is adjusted by the pilot, must be constantly updated after receiving orders through the CB radio link.

Cited regulations can be examined in dept in the Appendix B of this document.

From the functions shown above, the Goal to Function Tree for Study Case can be arranged, which is shown in Fig. 4.7.

**Prüfer Sequence for Goal to Function Tree** Then, for the tree shown in Fig. 4.7, and according to the nomenclature, the set  $L$  of numbered nodes of the tree is:

$$L = (fu_1, fu_2, fu_3, fu_4, fu_5, fu_6, fu_7, fu_8, fu_9, fu_{10}, fu_{11}, fu_{12}, fu_{13}, fu_{14}), fu_n \in \mathbb{N} \quad (4.1)$$

Applying the algorithms to find the Prüfer Sequence  $S$  is found that:

$$S = (fu_2, fu_2, fu_1, fu_3, fu_3, fu_6, fu_3, fu_8, fu_{11}, fu_{11}, fu_8, fu_3), a_n \in \mathbb{N} \quad (4.2)$$

And taking into account that:

$$F_u = L - (S \cap L) \quad (4.3)$$

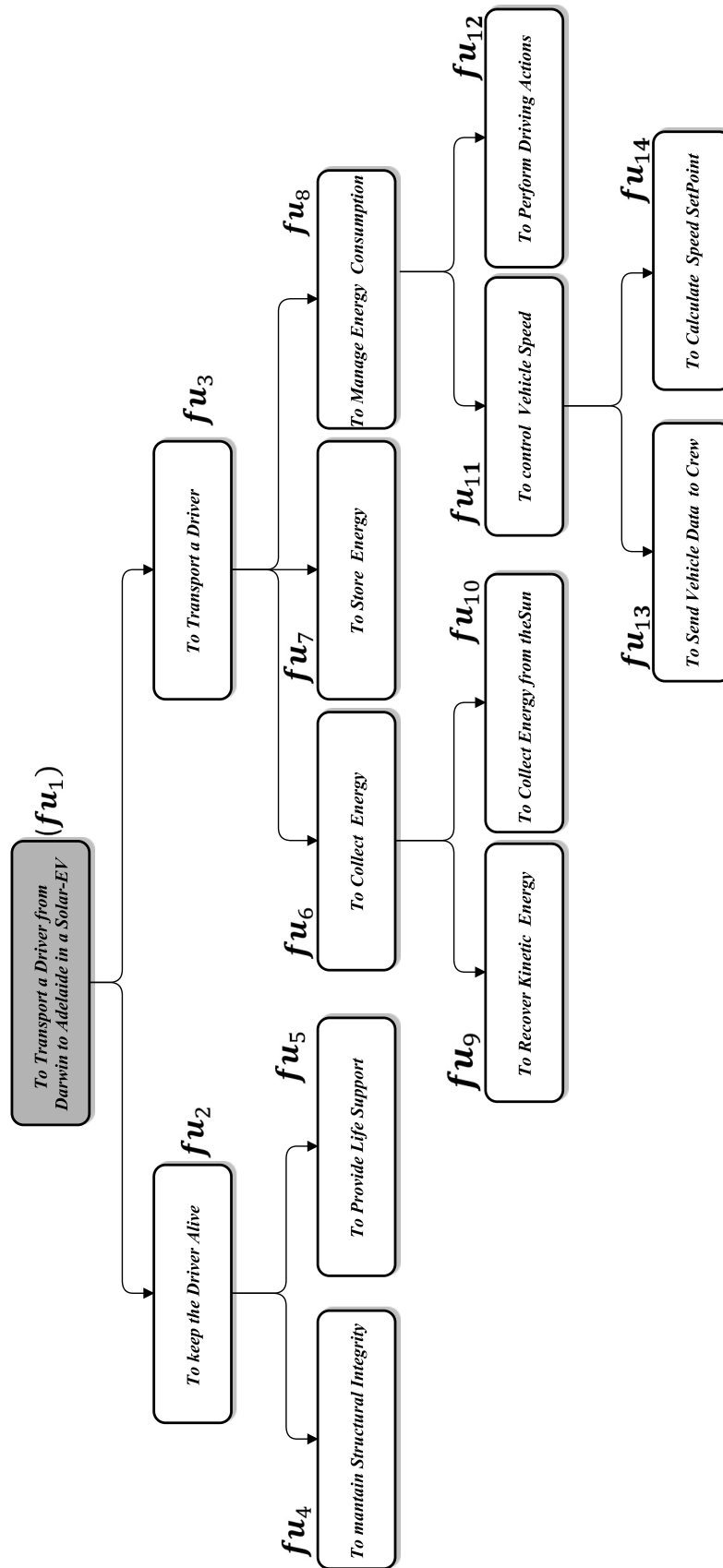

Figure 4.7: GFT for a WSC 2015 race and Challenger Class Vehicle

The set of basic functions  $F_u$  is:

$$F_u = (fu_4, fu_5, fu_7, fu_9, fu_{10}, fu_{12}, fu_{13}, fu_{14}), fu_n \in \mathbb{N} \quad (4.4)$$

On the set  $F_u$  of basic functions, the corresponding weights will be found.

#### 4.2.2.2 Basic Function weighing

**Neighborhood index** From the set of nodes of the tree that is presented in Fig.4.7, the number of neighbor functions  $Nn$  for the nodes of the tree is expressed as:

$$Nn = (1, 2, 2, 2, 2, 3, 3, 3, 2, 2, 2, 2, 2, 2) \quad (4.5)$$

From where, the set of neighborhood index for the tree nodes is:

$$K_v = [K_{v1}, K_{v2}, K_{v3}, K_{v4}, K_{v5}, K_{v6}, K_{v7}, K_{v8}, K_{v9}, K_{v10}, K_{v11}, K_{v12}, K_{v13}, K_{v14}] \quad (4.6)$$

$$K_v = \frac{1}{Nm} = [1, 0.5, 0.5, 0.5, 0.5, 0.333, 0.333, 0.333, 0.5, 0.5, 0.5, 0.5, 0.5, 0.5] \quad (4.7)$$

Then the weights of the tree nodes are as follows:

$$Wu_{(1)} = K_{v1} = 1 \quad (4.8)$$

$$Wu_{(2)} = K_{v2} * K_{v1} = 0.5 \quad (4.9)$$

$$Wu_{(3)} = K_{v3} * K_{v1} = 0.5 \quad (4.10)$$

$$Wu_{(4)} = K_{v4} * K_{v2} * K_{v1} = 0.25 \quad (4.11)$$

$$Wu_{(5)} = K_{v5} * K_{v2} * K_{v1} = 0.25 \quad (4.12)$$

$$Wu_{(6)} = K_{v6} * K_{v3} * K_{v1} = 0.1666 \quad (4.13)$$

$$Wu_{(7)} = K_{v7} * K_{v3} * K_{v1} = 0.1666 \quad (4.14)$$

$$Wu_{(8)} = K_{v8} * K_{v3} * K_{v1} = 0.1666 \quad (4.15)$$

$$Wu_{(9)} = K_{v9} * K_{v6} * K_{v3} * K_{v1} = 0.0833 \quad (4.16)$$

$$Wu_{(10)} = K_{v10} * K_{v6} * K_{v3} * K_{v1} = 0.0833 \quad (4.17)$$

$$Wu_{(11)} = K_{v11} * K_{v8} * K_{v3} * K_{v1} = 0.0833 \quad (4.18)$$

$$Wu_{(12)} = K_{v12} * K_{v8} * K_{v3} * K_{v1} = 0.0833 \quad (4.19)$$

$$Wu_{(13)} = K_{v13} * K_{v11} * K_{v8} * K_{v3} * K_{v1} = 0.04166 \quad (4.20)$$

$$Wu_{(14)} = K_{v14} * K_{v11} * K_{v8} * K_{v3} * K_{v1} = 0.04166 \quad (4.21)$$

From this analysis it is obtained that the vector of weights for the basic functions of the system, selected according to Prüfer Analysis is defined as:

$$Wu = [Wu_{(4)}, Wu_{(5)}, Wu_{(7)}, Wu_{(9)}, Wu_{(10)}, Wu_{(12)}, Wu_{(13)}, Wu_{(14)}] \quad (4.22)$$

$$Wu = [0.25, 0.25, 0.1666, 0.0833, 0.0833, 0.0833, 0.04166, 0.04166] \quad (4.23)$$

$$(4.24)$$

and must be fulfilled, for basic functions, that:

$$\sum_{i=1}^n Wu_{(i)} = 1 \quad (4.25)$$

### 4.2.3 Step 3: Operative Stages Analysis

From the mission description, the operational stages of the mission can be identified. Compiling some aspects of the analysis of step 1 of the methodology (shown in Chapter 4.2.1.1, it is possible to obtain

the states in which the vehicle is located for each operative stage, which will serve to construct the matrix of operational stages, as shown below:

**Operative Stage 1. Competition Day** *The organizers allow the vehicle battery pack to be charged at the start of the race, so the only source of energy available to the vehicle is energy recovered by the photo-voltaic array. During the first few minutes of the race, and as the vehicle gains speed and drains some of the battery power, it operates with the panel turned off in order to prevent the battery from overcharging. As the vehicle moves away from the city center, it can increase its speed, and the strategy team decides when it is necessary to turn on the solar array*

At the beginning of the competition, and while the vehicle is at the starting line, it is necessary to maneuver it, so the vehicle requires reversing. Due to the state of charge of the battery, and because it is necessary to avoid having an overvoltage condition, reverse maneuvers are performed with the solar array turned off. This is the mode of operation OS3.

During the day of competition, the vehicle is running at certain speed. During the first few minutes of running the solar panel is off. This mode of operation of the vehicle is called OS1. When the battery is at an adequate voltage level and the solar panel can be turned on, and while the vehicle is in motion, the mode of operation of the vehicle will be OS2.

**Operative Stage 2. Mandatory Control Stops** *The control stops are mandatory stops defined by the organization during the race, designed to control the position of competitors and ensure safety as the competition develops. In total, the organization has defined 9 mandatory stops at intervals between 4 and 6 hours apart, which implies that on average, a solar vehicle should make between 1.5 and 2 stops per day. The duration of the stops is 30 minutes counted from the moment the vehicle stops. During the stop control period, the vehicle can continue to use the solar panel to charge the battery. During the stop control time, the vehicle is turned on but with its motor in IDLE state until 30 minutes reached. The mode of operation of the vehicle will be in this case the OS7. In certain occasions, the vehicle must maneuver within the space of control stop (at the time of entering and leaving the assigned location), so it must move back and forth repeatedly (changing the direction of rotation of the motor). The vehicle is in OS4 operating mode.*

**Operative Stage 3. End of competition day** *After an appropriate demarcation of the place, the convoy moves to the stop site, where the SEV stops and is deployed in the same way as in a*

stop control. The amount of energy available is much lower than harvester earlier so the equipment decides (depending on the state of charge of the battery and the indications of the strategist) deploying the second concentration photovoltaic array. The vehicle is in an IDLE state, so the energy that is collected in the solar panel is stored in the battery. Because there are no time controls, the vehicle is deployed until collected net energy is equal to or less than instantaneous energy consumption (around 30Wh), at which point the battery cuts off. At this time, the vehicle goes to OFF state. During the night stops, and because the solar pickup potential is lower than the control stops, and if strategist decides to deploy the second solar concentration array, the vehicle is in OS6 operating mode. When battery must be removed from the vehicle, it is in OS5 operating mode (Vehicle off).

**Operative Stage 4. Start of day of competition** *The average day of competition begins at 4:00 AM, where the team wakes up and prepares to prepare the vehicle for the day of competition. By the geographical conditions of the Stuart Highway, direct sun rays appears after 6:00 AM Darwin hour. The equipment then has 2 hours to prepare the vehicle, as well as reinstall the battery and position the solar panel. In this case, the vehicle is driven to modes of operation OS6 or OS7 (the vehicle stopped, but with solar pickup) systems turned on based on the strategy team directions.*

#### 4.2.3.1 Operative Stages Matrix

From the above information, the matrix of operational states is constructed. For this case, each of the basic functions is related to the operating states as shown below. After analyzing each of the operating modes, the decimal point of the vector of operative states was calculated. In the end, the operational stages were reclassified as follows:

Table 4.2: Operative Stage Matrix. Both vehicle Modes of Operation and Basic Funtions for World Solar Challenge 2015

Vehicle Modes of Operation			<i>OS</i>	<i>fu</i> <sub>4</sub>	<i>fu</i> <sub>5</sub>	<i>fu</i> <sub>7</sub>	<i>fu</i> <sub>9</sub>	<i>fu</i> <sub>10</sub>	<i>fu</i> <sub>12</sub>	<i>fu</i> <sub>13</sub>	<i>fu</i> <sub>14</sub>	$ OS_{t_m} $	<i>OS'</i>
Run	Forward	No Collect	OS1	1	1	1	1	0	1	1	1	247	OS2'
Run	Forward	Collect	OS2	1	1	1	1	1	1	1	1	255	OS3'
Run	Reverse	No Collect	OS3	1	1	1	1	0	1	1	1	247	
Run	Reverse	Collect	OS4	1	1	1	1	1	1	1	1	255	
Stop	No Collect	No Concentrate	OS5	1	0	0	0	0	0	0	0	128	OS1'
Stop	Collect	Concentrate	OS6	1	0	1	0	1	0	1	0	170	OS4'
Stop	Collect	No Concentrate	OS7	1	0	1	0	1	0	1	0	170	
N				7	6	5	4	3	2	1	0		

Just for a single state, the vehicle is stopped and turned off, without performing any power pickup operation. Initially defined as the *OS5*, is re categorized as the *OS1'* operating state. In terms of the basic functions of the mission, the operating states *OS1* and *OS3* do not present differences (so from the perspective of the analysis of the objectives are equal) so they are re categorized and become the operational state *OS2'*. With respect to the operating state *OS2* and the operating state *OS4*, are re categorized in the operating state *OS3'*. Finally, the operating states *OS6* and *OS7* are re categorized as the operating state *OS4'*. At the end, the resulting matrix of operational states of the mission is shown below:

$$OS' = \begin{bmatrix} OS1' \\ OS2' \\ OS3' \\ OS4' \end{bmatrix} = \begin{bmatrix} 1 & 0 & 0 & 0 & 0 & 0 & 0 & 0 \\ 1 & 1 & 1 & 1 & 0 & 1 & 1 & 1 \\ 1 & 1 & 1 & 1 & 1 & 1 & 1 & 1 \\ 1 & 0 & 1 & 0 & 1 & 0 & 1 & 0 \end{bmatrix} \quad (4.26)$$

And, based on photos taken during the competition, OS are shown in Fig. 4.8

## 4.2.4 Step 4: Functional Structure Analysis

### 4.2.4.1 System Functional Structure

Mechanical and electronic design information was used to perform the functional analysis of the vehicle. for simplification purposes, matter flows were omitted from the FD analysis. Mass flows are related to mechanical supports in the vehicle. Matter loss in wheels has not been taken into account.

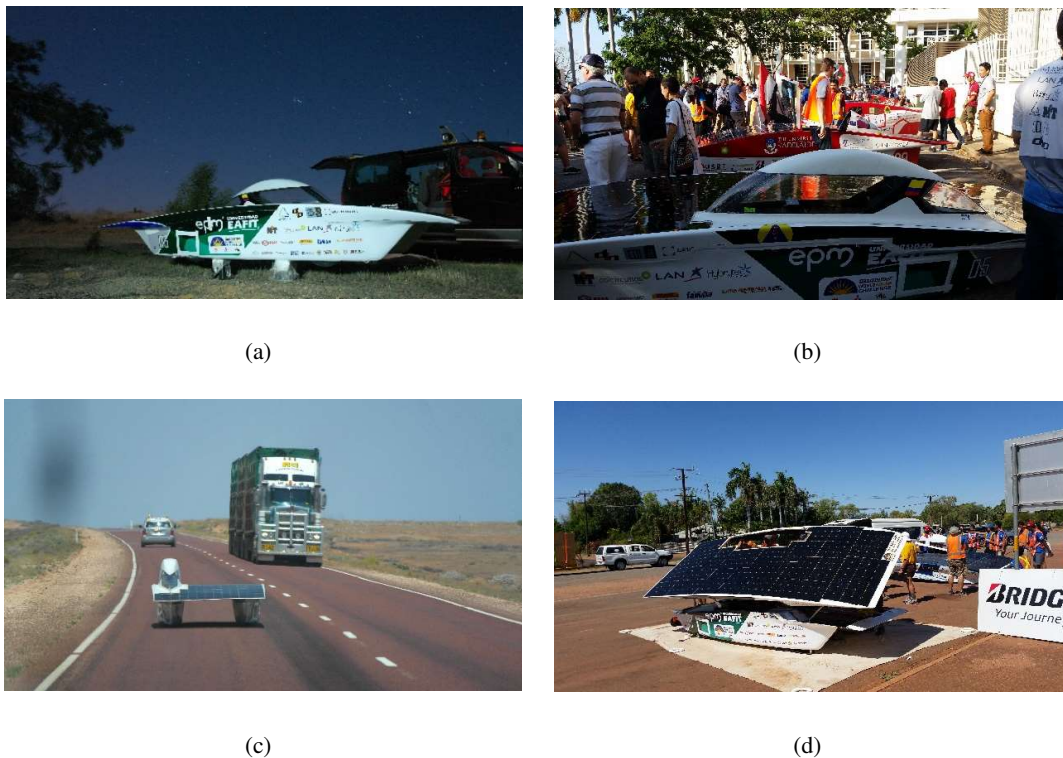

Figure 4.8: Photos for OS of *Primavera 2* during World Solar Challenge 2015 for  $OS_1$  4.8(a), for  $OS_2$  4.8(b), for  $OS_3$  4.8(c) and  $OS_4$  4.8(d)

The signal and energy flows were defined for the vehicle. The changes present in the energy flows of the vehicle are monitored within each device using proprietary internal sensors which send their information through a digital communication protocol. As a note, The arrangement of the components in the functional diagram does not correspond to the actual distribution of vehicle components and communication buses. The result can be seen in Fig. 4.9.

The vehicle subsystems are broken down as follows:

**Solar Array.** The solar panel uses a photovoltaic array of about 300 mono crystalline Silicon cells, which are connected in series to Maximum Power Point Trackers (MPPT), which allow to be tied to vehicle's DC bus.

**Energy Storage System.** The main storage system consists of three main elements: the Lithium rechargeable cells, the BMS (or Battery Management System) system that manages the loading and unloading of lithium cells, as well as protecting the battery against any Anomaly in the cells; And the DC-DC converter that powers the vehicle's main systems and accessories (reverse camera, whistle,

lights, radio communication, etc.).

**Control System.** The control system links the pilot actions to the electronic systems of the vehicle. It calculates the speed of the vehicle according to the position of the throttle potentiometer; as well as receiving the activation signals of the lights and the claxon. Also, stores temporarily the information sent by the other subsystems of the vehicle and sending it through the wireless transmitter.

**Propulsion System.** Is composed of three subsystems: the Electronic Speed Controller or ESC, which is responsible for generating the three-phase power required by the motor to operate. The ESC also modulates the frequency of motor leads, and increasing or decreasing motor speed, changing vehicle speed. Line inductance (passive components) are used to adjust the voltage required by the motor to operate. The in-wheel motor (HUB motor), which is contained within the wheel rim and is responsible for converting electric power into mechanical rotational power.

**Steering System.** it is in charge of directing the movement of the vehicle according to the movement of the steering wheel. Is composed of the steering wheel, which connected to a steering column, moves a system of bars and a steering rack, which in turn, moves the bars where the front wheels of the vehicle are mounted.

**Brake System.** Is composed of a brake pedal, which is responsible for pressing a hydraulic cylinder. This cylinder compresses the fluid, and through hoses, reach the brake jaws, and perform braking action by compressing a steel disk.

**Bodywork.** Has an aerodynamic shape that allows to cut the wind and reduce power consumption due to drag force. Is a passive, unchanging system, so it is not taken into account for the analysis.

#### 4.2.4.2 Addition of Sensors

Almost all of the vehicle sensor and instrumentation devices come from the electronics devices itself, such as speed controllers, motors, MPPT and BMS. In order to find out if more variables were required to be monitored, the vehicle's mission control team evaluated additional variables based on the specific requirements of each of the subsystems. Taking into account the criteria of inclusion of sensors (Feasibility, necessity and degradation), the analysis was done and is shown in Fig. 4.10.

It should be noted that for the solar array subsystem, a current and voltage meter based on CAN communication was required for NOMURA MPPT based solar modules. which does not have telemetry systems as it works as a stand alone devices. Solar cells temperatures were also required to estimate cell efficiency and its thermal losses. To simplify the design of the new sensor cluster, it was

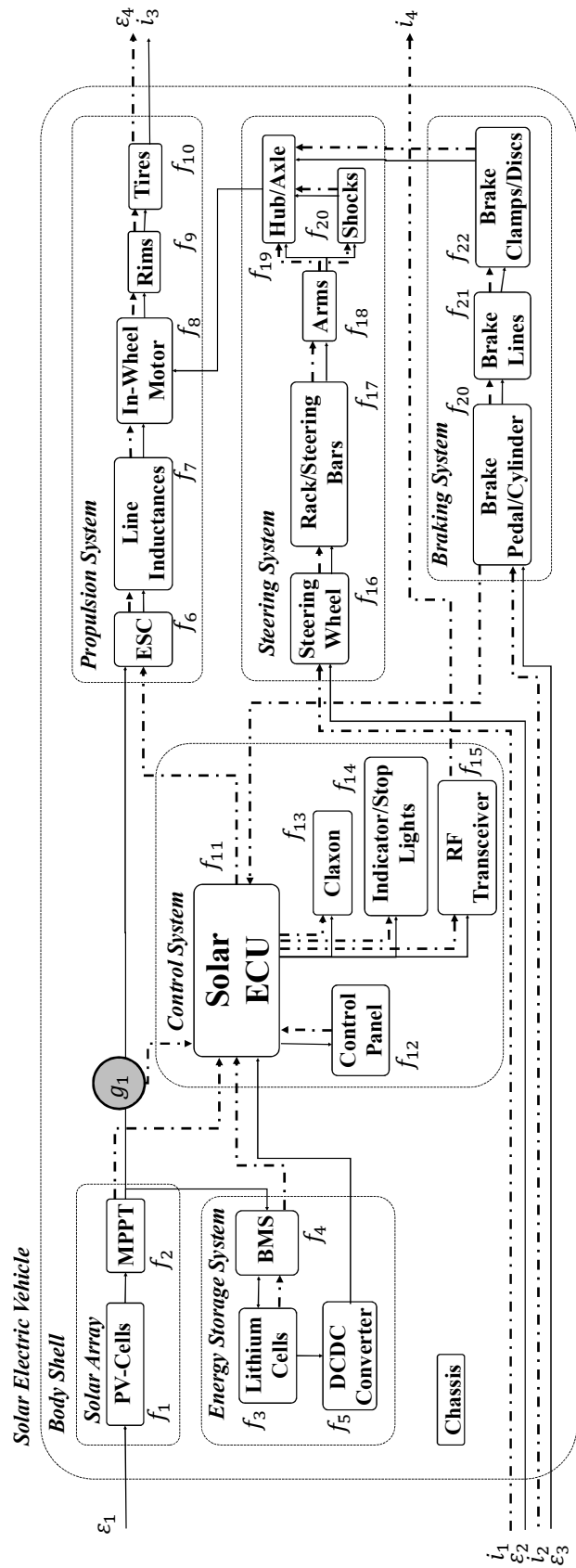

Figure 4.9: Simplified FD of Primavera 2 based on the analysis of its subsystems.

Subsystem	To Measure	Feasibility	Need	Degradation	Decision	Comments		
Solar Array	PV_array	$f1$	Cell Temperature	A PTC Thermistor is available. Installation underneath Solar array - direct measurement	Solar Cell temperature affects array performance. Maximum temperature of 70°C	Increases vehicle power consumption. Negligible power consumption. Requires CAN data bus, available	Install	Approved. Sensor integration in low power consumption CAN Node.
	MPPPT	$f2$	Output Voltage	Current integrator module available	Nomura MPPPT doesn't send telemetry data. Required to estimate solar power harvesting	Increases vehicle power consumption. Negligible power consumption. Requires CAN data bus, available	Install	Approved. Copy of Some PV Array and MPPPT Node
Energy Storage System	Lithium Cells	$f3$	Output Voltage	Current integrator module available	direct Tritium BMS Current Integrator backup measurement and energy calculation	Required to calculate available battery energy. Increases vehicle power consumption. Negligible power consumption. Requires CAN data bus, available	Install	Approved. Copy of Some PV Array and MPPPT Node
	Tyres	$f10$	Tyre pressure	A wireless Pressure sensor can be installed within direct measurement	Tyre pressure affect vehicle rolling resistance coefficient and increases power consumption	Requires installation of auxiliary battery. Regulations restrains to 2Wh capacity for auxiliary batteries, 0.5Wh/per tyre (3.7l@130m4h).	Not Install	Discarded. Tyre pressure can be adjusted during comping overnight
Steering System	Steering Wheel	$f16$	Steering angle	A rotary encoder can be installed near steering column - indirect measurement	Driver steering behavior influence power consumption	Requires ECU Debugging and control strategy	Not Install	Discarded. Adjusted steering actions by pilot training
	Shocks	$f20$	Suspension Compression	Accelerometer available	Suspension rebound. Allows to adjust incidence calculation of compression angle	Power consumption of 12.5Wh/race. Negligible power consumption.	Not Install	Discarded. Shocks characterization and incidence angle adjustments during tests.
Brake system	Brake cylinders	$f21$	Brake activation	Inductive type available	sensor allows to detect braking and increases reliability of actual sensor - backup device	Power consumption of 10Wh/race. Negligible power consumption. Requires brake pedal holder design and calibration.	Not Install	Discarded. Improving of actual pedal sensor and pedal holder redesign

Figure 4.10: Sensor addition criteria for Primavera 2.

decided to merge both Temperature and Current/Voltage measurements in a same device shown in Fig. 4.11.

For the battery cells, an indirect measurement was required. From lithium cells current and voltage measurements, energy count (Coulomb per second times voltage) can be performed through an iterative integration algorithm. By using the same hardware design of NOMURA MPPT sensor cluster, this measurement could be achieved.

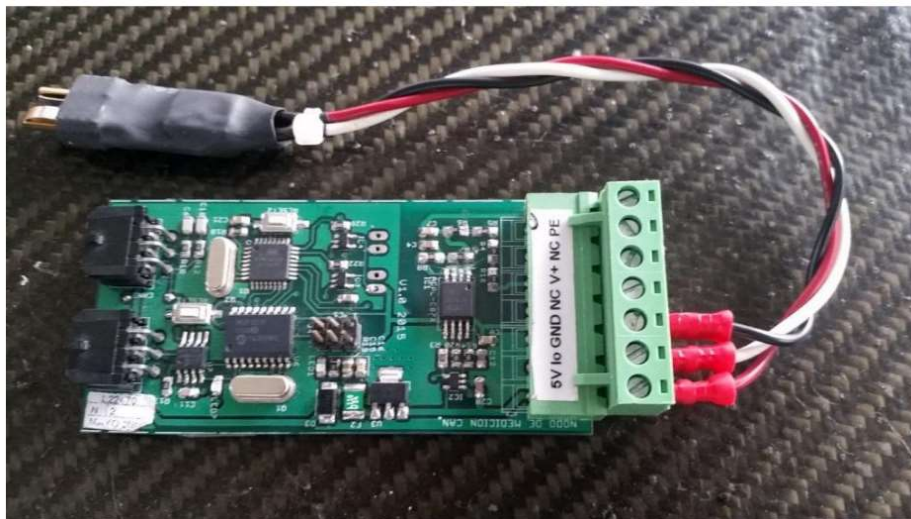

Figure 4.11: Current, voltage and temperature CAN node for *Primavera 2* Solar array and battery pack.

The tyre pressure sensors were not included because the competition restrains the use of auxiliary batteries in the vehicle. Auxiliary batteries were required for these sensors because they cannot be supplied from the main battery pack, as they're installed in a pressurized wheel in rotational motion. Also, technical limitations and available time influenced this decision.

With respect to the suspension system, it was decided to characterize the suspension during its design process, adjusting the angle of attack of the vehicle prior to the competition. The bump and springs stiffness were also adjusted in advance, based on the effectiveness of the brake system and the weight distribution of the vehicle, also design parameters.

An additional brake sensor (as an auxiliary input to the braking algorithm for motor speed controller) as well as the steering wheel position sensor involved further reprogramming of the Solar ECU, showing instability during testing. Then, due to tight schedules, these sensors were discarded.

At the end, 168 variables were selected, coming predominantly from the motor, speed controller,

solar panel, and battery, in addition to those that were included with the sensor addition process. With respect to the mechanical subsystems, they were parametrized and adjusted prior to competition, so the vehicle strategy team (Operators) decided not to monitor these mechanisms as they do not present significant changes that must be measured, unless a fault occurs, forcing the vehicle to stop. Strategy Team decided to monitor this mechanical parameters using radio Link and asking the Driver to report anomalies.

## 4.2.5 Step 5: Function to Data Matrix

### 4.2.5.1 Experts Score

For the experts qualification, the blank FDM format was given to Strategy Team, showing both the final variable list, the FD obtained in the previous step and the GFT. In order to facilitate the qualification process, experts were instructed on how FDM was generated, they were asked, for the relevant subsystems:

*Rate according to your criteria, what is the relationship between the variable  $v_i$  and the basic function  $f_{u_i}$ , according to the main objective of Primavera2 in the Bridgestone World Solar Challenge 2015. Rate each variable with 0 (Unrelated), 1 (Weak Relationship), 3 (Medium Relationship) and 9 (Strong Relationship).*

Finally, VRI was calculated according to the operating states of the system. For example, the results of some variables for the FDM obtained, in operating state  $OS'_3$ , in the Table 4.12, are shown. The complete FDM tables for the four operating states can be seen in the Appendix C from Fig. C.1 to Fig. C.8. The corresponding VRI values can be extracted, in each operational state as shown in a simplified way in Table 4.12. the complete table can be seen in the Appendix C in Figures C.9 to C.11.

It can be seen that the highest VRI values were obtained for the operating state  $OS_3$ , corresponding to the vehicle running with the solar panel turned ON is the main operating state of the race. Regarding to  $OS_1$ , which corresponds to the vehicle in a stopped state (vehicle off), the VRI values are zero (canceled). This is consistent with the fact that while the vehicle is off all subsystems are also off, and the vehicle is stopped.

Based on  $OS_3$  (running vehicle with solar array ON), as it has the highest VRI values, the variables were rearranged, and the trends of the VRI values of the operative states  $OS'_2$  and  $OS'_4$  were reviewed. To obtain acceptable determination coefficients, 6th order polynomial regression curves

FLOWS	VARIABLE	ATTRIBUTES										BASIC FUNCTIONS										Variable Relevance OS'n wfu
		alpha	Beta	Gamma	Delta (Hz)	FU4	FU5	FU7	FU9	FU10	FU12	FU13	FU14	FU14								
f4-f11	Battery pack voltage & current					0,25	0,1667	0,0833	0,0833	0,0833	0,0417	0,0417	0,0417	0,403								
f4-f11	Battery Voltage (mV)	00	V/1000	(90,147)	10	0	9	9	9	3	0	9	9	0,403								
f4-f11	Battery Current (mA)	01	A/1000	(0,30)	10	0	9	9	9	3	0	9	9	0,403								
f4-f11	Pack SOC					0	9	9	3	3	0	9	9	0,347								
f4-f11	SOC (Ah). Shows Ah consumed from the pack. 0 = Full, and counts upwards towards the user-set pack capacity number as Ah are used. Resets to 0 when max cell reaches balance threshold.	00	Ah	(0,40.8)	1	0	9	9	3	3	0	9	9	0,347								
f4-f11	Shows the SOC as a percentage. 100% = full, 0% = empty	10		(0,100)	1	0	9	9	3	3	0	9	9	0,347								
f2-f11'	Battery Voltage (mV)	00	V/1000	(90,147)	0	0	9	9	3	3	0	9	9	0,347								
f2-f11'	Battery Current	01	A	(0,30)	0	0	9	9	3	3	0	9	9	0,347								
f4-f11	Maximum cell voltage (mV)	00	v/1000	(2,6,4,2)	10	0	9	9	3	3	0	9	9	0,319								
f11-f6	Bus Voltage - DC bus voltage at the controller.	00	V/1000	(90,147)	5	0	9	9	3	3	0	9	9	0,292								
f2-f11'	Capacity (mAh)	00	Ab/1000	(0,40,8)	0	0	9	3	3	3	0	9	9	0,273								
f4-f11	Minimum cell voltage (mV)	00	V/1000	(2,5,4,2)	10	0	9	9	3	3	0	9	9	0,264								
f4-f11	Status Flags	10	0	NA	1	0	9	3	3	3	0	9	9	0,264								
f2-f11	Uout(output Voltage)	00	V	(90,147)	0	0	9	9	9	9	0	9	9	0,250								
f4-f11	Total pack capacity (Ah)	00	Ah	(0,40,8)	10	0	9	3	0	0	0	9	9	0,236								
f4-f11	Status Flags	10	0	NA	1	0	9	3	0	3	0	9	9	0,236								
f2-f11	BVLR- Battery Voltage Level Reached Flag (0= Uout<UoutMax, 1=Uout=UoutMax)	20	V	NA	0	0	9	9	9	9	0	9	9	0,222								
f2-f11	BVLR- Battery Voltage Level Reached Flag (0= Uout<UoutMax, 1=Uout=UoutMax)	20	V	NA	0	0	9	9	9	9	0	9	9	0,222								
f4-f11	Battery pack status					0	9	0	3	1	0	9	9	0,218								
f11-f6	Odometer - Distance the vehicle has travelled since reset.	00	m	NA	1	0	9	0	9	9	0	9	9	0,208								
f11-f6	Bus Current - Current drawn from the DC bus by the controller.	00	A	(0,30)	5	0	9	0	0	0	0	9	9	0,181								
f4-f11	Maximum cell temperature ( 1/10th °C)	00	°C/10	(20,55)	1	0	9	0	0	0	0	9	9	0,171								
f4-f11	Cell number in CMU that is the minimum cell voltage	10	V/1000	NA	10	0	9	0	0	0	0	9	9	0,167								
f4-f11	Cell number in CMU that is the maximum cell voltage	10	V/1000	NA	10	0	9	0	0	0	0	9	9	0,167								
f11-f6	Error Flags	20	0	NA	5	0	9	0	9	9	0	9	9	0,167								
f11-f6	Limit Flags	10	0	NA	5	0	9	0	9	9	0	9	9	0,167								
f11-f6	Vehicle Velocity- Vehicle velocity in metres / second	01	m/s	(16,6, 33,3)	5	0	9	0	3	0	9	9	9	0,153								
f2-f11	Iin(Input Current)	00	A	(0,4)	0	0	9	0	9	9	0	9	9	0,153								
f2-f11	Uin (Input Voltage)	00	V	(36-141,4)	0	0	9	0	9	9	0	9	9	0,125								
f2-f11	OVT- Overtemperature Flag (0= Temp<95°C, 1=Temp>=95°C)	20	°C	NA	0	0	9	0	9	9	0	9	9	0,083								
f11-f6	Motor Velocity (rpm) Desired motor velocity set point in rpm	01	(pi/30)Ra d/s	(850,1100)	4	0	9	0	9	9	0	9	9	0,079								
f4-f11	Balance SOC					0	9	0	3	0	0	9	9	0,069								

Figure 4.12: Summary of FDM for Primavera 2. Selected Information across basic functions were obtained from GFT presented in Fig.4.7

were calculated from Figures 4.13(b), 4.13(c) and 4.13(d), describing the trend curves for  $OS'_2$ ,  $OS'_3$  and  $OS'_4$ , respectively.

$$\begin{aligned}
 VRI(v_i, OS'_2) &= -9x10^{-13}v_i^6 + 4x10^{-10}v_i^5 - 7x10^{-8}v_i^4 + 4x10^{-6}v_i^3 + 7x10^{-5}v_i^2 - 0,0132v_i + 0,3757, R^2 = 0.9547 \\
 VRI(v_i, OS'_3) &= -1x10^{-12}v_i^6 + 4x10^{-10}v_i^5 - 7x10^{-8}v_i^4 + 4x10^{-6}v_i^3 + 8x10^{-5}v_i^2 - 0,0151v_i + 0,4357, R^2 = 0.9849 \\
 VRI(v_i, OS'_4) &= -1x10^{-12}v_i^6 + 4x10^{-10}v_i^5 - 7x10^{-8}v_i^4 + 4x10^{-6}v_i^3 + 8x10^{-5}v_i^2 - 0,0151v_i + 0,4357, R^2 = 0.9849
 \end{aligned}
 \tag{4.27}$$

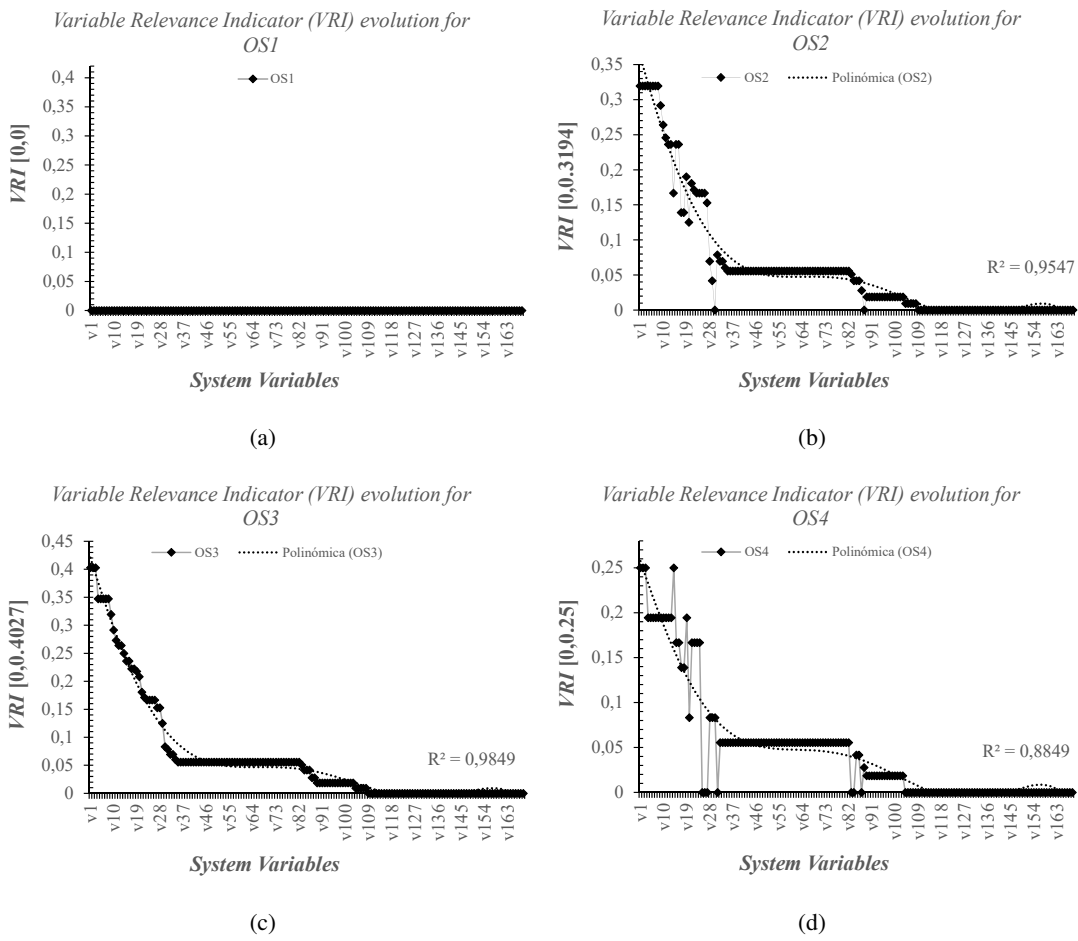

Figure 4.13: VRI value tendency for  $OS_1$  4.13(a), for  $OS_2$  4.13(b), for  $OS_3$  4.13(c) and  $OS_4$  4.13(d)

When performing the comparison between the trend lines of the VRIs for the operating states  $OS_2$ ,  $OS_3$  and  $OS_4$  (using the Fig. 4.13) and shown in Fig. 4.14, and maintaining the same order of the variables established for  $OS'_3$ , it was found that for the operating states  $OS'_2$  and  $OS'_4$ , There were similar trends to  $OS'_3$ .

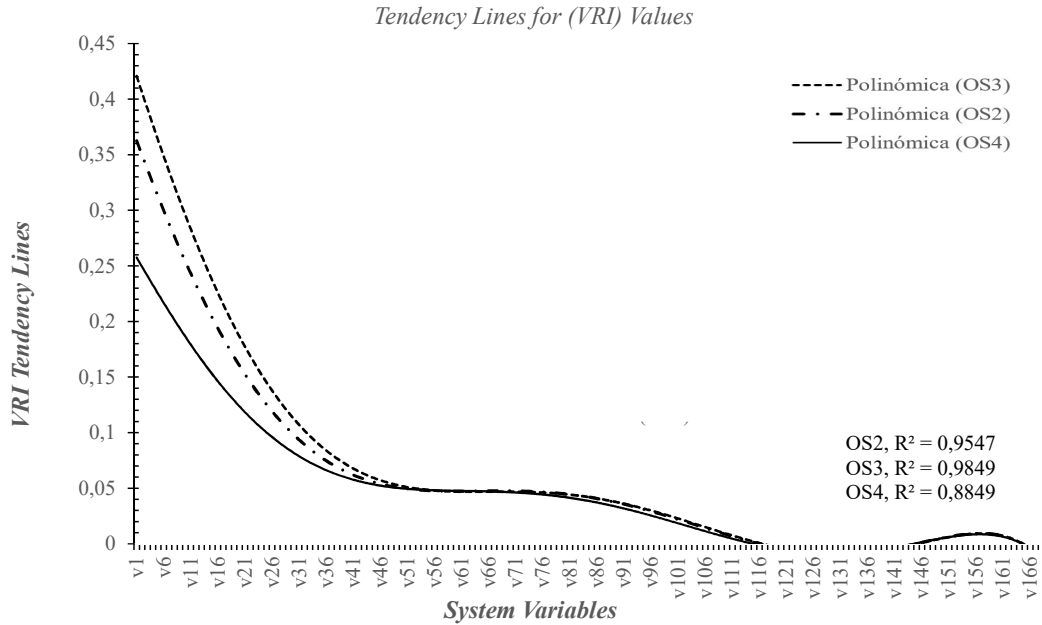

Figure 4.14: VRI Tendency lines comparative for  $OS_2$ ,  $OS_3$  and  $OS_4$

#### 4.2.6 Variable Relevance Indicator Threshold

It is evident (in a graphical form), that, from the variable  $V_{109}$ , the VRI values for all variables in all operating states are zero. This indicates that these variables were eliminated in the FDM without having passed even the minimum threshold values. Then, for each operating state, the maximum values of VRI are established for the variables, from which the maximum values are:

$$\max [P_{fj}(OS'_1)] = 0 \quad (4.28)$$

$$\max [P_{fj}(OS'_2)] = 0,31944 \quad (4.29)$$

$$\max [P_{fj}(OS'_3)] = 0,402777 \quad (4.30)$$

$$\max [P_{fj}(OS'_4)] = 0,25 \quad (4.31)$$

As a first approximation, a threshold adjustment value of  $K_{Th} = 0.7$  was set by the solar vehicle strategy team. Taking as reference the maximum values of the VRI, the threshold values for the operating states are:

$$\begin{bmatrix} FDM_{OS'_1} \\ FDM_{OS'_2} \\ FDM_{OS'_3} \\ FDM_{OS'_4} \end{bmatrix} = \begin{bmatrix} Th_{OS'_1} \\ Th_{OS'_2} \\ Th_{OS'_3} \\ Th_{OS'_4} \end{bmatrix} = \begin{bmatrix} 0.000000 \\ 0.095833 \\ 0.120833 \\ 0.075000 \end{bmatrix} \quad (4.32)$$

When applying the expression 3.32 to the list of variables with their respective VRI values, about 30 variables with the highest VRIs were selected. It should be noted that those variables that were eliminated only in some OS. Those variables, shown in green, are the ones with higher VRI values, while those with dark red colors have the lowest scores. Those highlighted in black, were removed for the corresponding OS. The final variable list, with their respective VRI values and the application of the threshold, can be observed in Fig. 4.15, and graphically, in Fig. 4.16, where is shown the effects off threshold over the whole set of variables, and the behavior of the variables that surpassed the threshold values.

From the table shown in Fig. 4.15, changes in VRI values are evident in the four OS found for the solar vehicle. As expected, for the operating state  $OS'_1$ , the method removed all variables since the vehicle is off and can not transmit information via the telemetry link. The highest VRI values, belonged to  $OS'_3$ , which corresponds to the running vehicle (which represents about 90% of the total time of competition). It was found that the variables with higher score come predominantly from the battery system, concentrating on measuring the states of voltage and current (which ultimately express the state of charge and the amount of energy available, which the design of the vehicle optimization strategy was based). Then there are auxiliary variables of the battery that allow to know its state of health, as is the voltage of the battery cell most loaded and less loaded, as well as the alarms of battery status. The operating status of the solar panel, as well as engine error alarms, vehicle speed and engine angular speed (as the speed of the vehicle is a direct function of the engine angular velocity), the latter appears with a lower VRI score for this OS.

Regarding to the  $OS'_4$  (corresponding to the stopped vehicle and charging with the solar panel), the battery variables are found to lose weight while the vehicle speed variable disappears (when stopped).

#### 4.2.6.1 Implementation: Bridgestone World Solar Challenge 2015

After the theoretical application of the method, and taking as reference the list of variables and their VRI values from Fig. 4.15, the implementation of the graphical interface was performed. For this, an

Var	VARIABLE/VRI Values	VRI VALUES				VRI after threshold			
		Threshold Adjustment 0,7				Threshold			
		0,0000	0,3194	0,4028	0,2500	0	0,0958	0,1208	0,0750
		OS1	OS2	OS3	OS4	OS1	OS2	OS3	OS4
v1	Battery pack voltage & current	0,0000	0,3194	0,4028	0,2500		0,3194	0,4028	0,2500
v2	Battery Voltage (mV)	0,0000	0,3194	0,4028	0,2500		0,3194	0,4028	0,2500
v3	Battery Current (mA)	0,0000	0,3194	0,4028	0,2500		0,3194	0,4028	0,2500
v4	Pack SOC	0,0000	0,3194	0,3472	0,1944		0,3194	0,3472	0,1944
v5	SOC (Ah). Shows Ah consumed from the pack. 0 = Full, and counts up	0,0000	0,3194	0,3472	0,1944		0,3194	0,3472	0,1944
v6	Shows the SOC as a percentage. 100% = full, 0% = empty	0,0000	0,3194	0,3472	0,1944		0,3194	0,3472	0,1944
v7	Battery Voltage (mV)	0,0000	0,3194	0,3472	0,1944		0,3194	0,3472	0,1944
v8	Battery Current	0,0000	0,3194	0,3472	0,1944		0,3194	0,3472	0,1944
v9	Maximum cell voltage (mV)	0,0000	0,2917	0,3194	0,1944		0,2917	0,3194	0,1944
v10	Bus Voltage - DC bus voltage at the controller.	0,0000	0,2639	0,2917	0,1944		0,2639	0,2917	0,1944
v11	Capacity (mAh)	0,0000	0,2454	0,2731	0,1944		0,2454	0,2731	0,1944
v12	Minimum cell voltage (mV)	0,0000	0,2361	0,2639	0,1944		0,2361	0,2639	0,1944
v13	Status Flags	0,0000	0,2361	0,2639	0,1944		0,2361	0,2639	0,1944
v14	Uout(output Voltage)	0,0000	0,1667	0,2500	0,2500		0,1667	0,2500	0,2500
v15	Total pack capacity (Ah)	0,0000	0,2361	0,2361	0,1667		0,2361	0,2361	0,1667
v16	Status Flags	0,0000	0,2361	0,2361	0,1667		0,2361	0,2361	0,1667
v17	BVLR- Battery Voltage Level Reached Flag (0= Uout<UoutMax, 1=Uo	0,0000	0,1389	0,2222	0,1389		0,1389	0,2222	0,1389
v18	BVLR- Battery Voltage Level Reached Flag (0= Uout<UoutMax, 1=Uo	0,0000	0,1389	0,2222	0,1389		0,1389	0,2222	0,1389
v19	Battery pack status	0,0000	0,1898	0,2176	0,1944		0,1898	0,2176	0,1944
v20	Odometer - Distance the vehicle has travelled since reset.	0,0000	0,1250	0,2083	0,0833		0,1250	0,2083	0,0833
v21	Bus Current - Current drawn from the DC bus by the controller.	0,0000	0,1806	0,1806	0,1667		0,1806	0,1806	0,1667
v22	Maximum cell temperature ( 1/10th °C)	0,0000	0,1713	0,1713	0,1667		0,1713	0,1713	0,1667
v23	Cell number in CMU that is the minimum cell voltage	0,0000	0,1667	0,1667	0,1667		0,1667	0,1667	0,1667
v24	Cell number in CMU that is the maximum cell voltage	0,0000	0,1667	0,1667	0,1667		0,1667	0,1667	0,1667
v25	Error Flags	0,0000	0,1667	0,1667	0,0000		0,1667	0,1667	
v26	Limit Flags	0,0000	0,1667	0,1667	0,0000		0,1667	0,1667	
v27	Vehicle Velocity- Vehicle velocity in metres / second	0,0000	0,1528	0,1528	0,0000		0,1528	0,1528	
v28	Iin(Input Current)	0,0000	0,0694	0,1528	0,0833			0,1528	0,0833
v29	Uin (Input Voltage)	0,0000	0,0417	0,1250	0,0833			0,1250	0,0833
v30	OVT- Overtemperture Flag (0= Temp<95°C, 1=Temp>=95°C)	0,0000	0,0000	0,0833	0,0833				0,0833
v31	Motor Velocity (rpm) Desired motor velocity set point in rpm	0,0000	0,0787	0,0787	0,0000				
v32	Balance SOC	0,0000	0,0694	0,0694	0,0556				
v33	Balance SOC (Ah). Shows Ah supplied to the pack since the first cell be	0,0000	0,0694	0,0694	0,0556				
v34	Minimum cell temperature ( 1/10th °C)	0,0000	0,0602	0,0602	0,0556				

Figure 4.15: VRI Values for variable selection after applying a threshold adjustment value of  $K_{Th} = 0.7$

open source software platform called *Qt* was used. This programming platform has graphical tools for generating two-axis graphs, on which different variables can be visualized with respect to time. Because the focus of the work was on the calculation of the relevance of the variables but not on the generation of the graphical interface, variations of the proposal of the team *NUON* from *TUDeft* [Van Baar et al., 2014] were applied, with respect to the implementation of tabs for each subsystem (in a generic form, a *MAIN* tab with the major set of competition variables, a *ELECTRONICS* tab with information corresponding to the performance of the motor, and a *SOLAR* tab with the corresponding variables both from the *NOMURA* modules and to the main solar array of the vehicle.

Some secondary variables (which are calculated through other variables measured in the vehicle), were included, as *Torque* (calculated from the linear velocity of the vehicle and the instantaneous

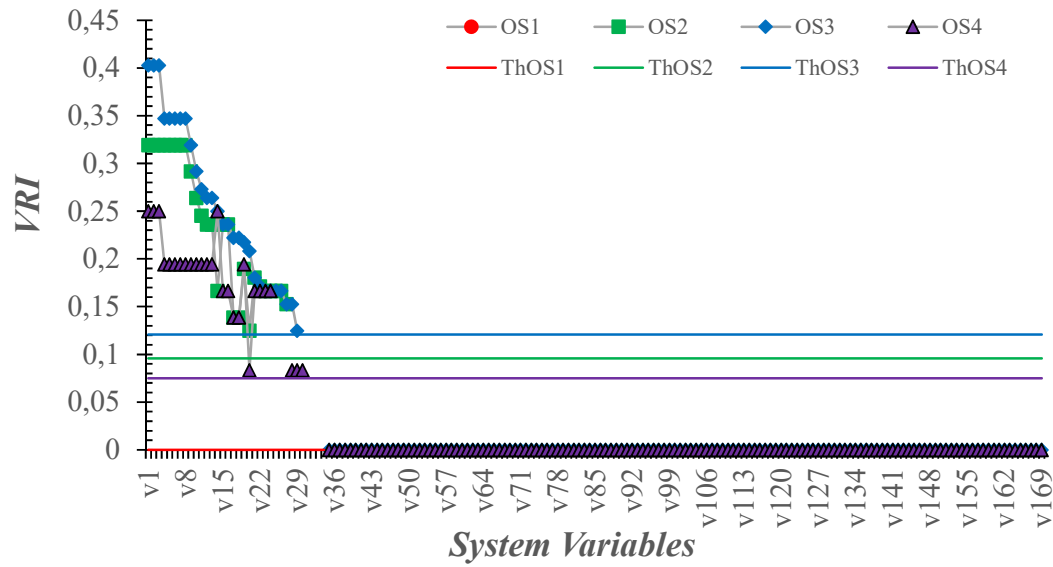

(a)

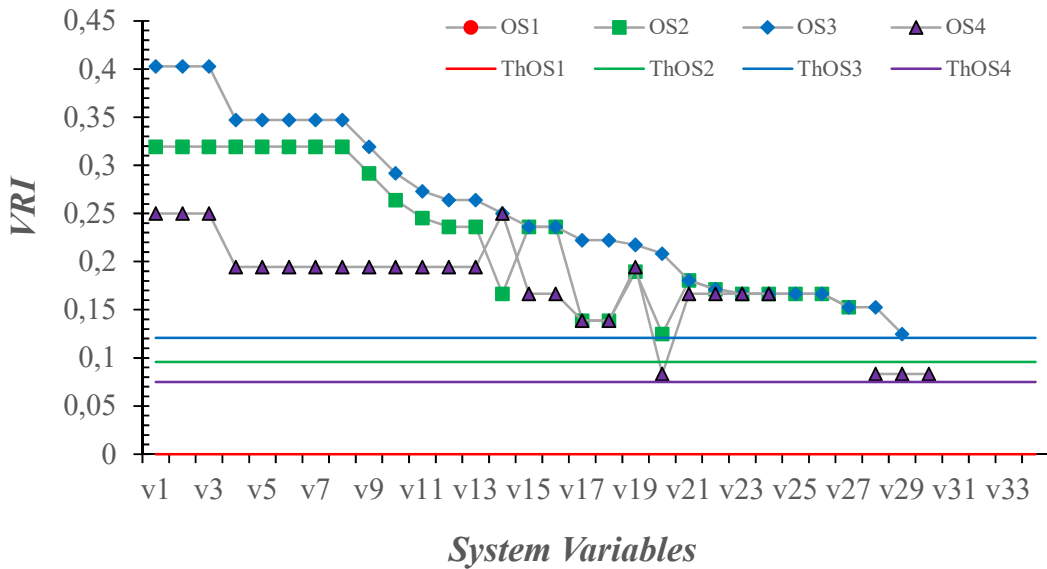

(b)

Figure 4.16: VRI Values for variable selection after applying a threshold adjustment value of  $K_{Th} = 0.7$ . Threshold effect on the complete set of variables 4.16(a). Threshold effect on the final set of variables. 4.16(b)

power consumption), and *Power Consumption* (calculated from the voltage of The battery and DC bus current, also from the battery). In addition, as a recommendation of strategy staff of other solar vehicle equipment, it was included a log-type application, showing vehicle real time position on geographic

coordinates, with the support of satellite maps. Also, and average values and historical data were included.

Using the attributes of the variables (obtained by applying the section 3.4.3), the graphs of the competition HMI were adjusted. The vehicle data were packaged in frames of about 600 Bytes and stored as flat files on the monitoring computer at 1-second intervals (period of predominant sampling obtained from the characterization of the variables).

To verify the functionality of the interface programming, field tests were carried out with the vehicle in circular routes through the main highways of the city, in circuits of around 20km. A second test of functionality was performed earlier in competition in the *Berry Springs* area, over *Cox Peninsula* road in *Darwin, Northern Territories, Australia*. An image of the HMI main screen designed for the solar vehicle is shown in Fig. 4.17.

During the competition, the vehicle was monitored using the proposed graphical interface. On the first day of competition, it was found that the variable *Torque* (which was included subsequent to the application of the method) was not required for the control of the vehicle during the following days. The *Battery Power* variable (expressed in *KWh*) became the primary measurement of vehicle's performance, as well as its *Speed*. For the operative state  $OS'_3$  (vehicle running), *Battery Voltage and Current* had the highest score, with a VRI value  $P_{fj} = 0.4028$ . So too, *Battery Power*, which is based on this same variable, took relevance during the competition.

The input power values of the solar panel (expressed by the calculation of the variables  $I_{in}$  and  $U_{in}$  (Solar array input Current and Voltage) with VRI values of  $P_{fj} = 0.1528$  and  $P_{fj} = 0.1250$  respectively, became relevant during the problems that occurred on the solar panel operation, when the vehicle crossed the control stop of *Alice Springs*, in the middle of competition. The increase in the relevance of this variable by the moment of failure was not studied due to the scope of this work, but, can be studied in the future.

Also, from day *TWO* of competition, a variable called *Specific power consumption* (SPC) was calculated, from the power consumption of the vehicle and the odometer value of the vehicle, ( $P_{fj} = 0.2083$  for the  $OS'_3$ ), seeking to know the trends of consumption of the pilot and vehicle. This variable was calculated from the interface measurements every 15 minutes, whose results were recorded in *Microsoft Excel*, and used to know the wind states (knowing from the strategy algorithm, the estimated slope value of road). For informative purposes, the evolution of this variable is shown in Fig. D.1. SPC allowed the strategy team to change the vehicle speed to reduce race time in the initial part of

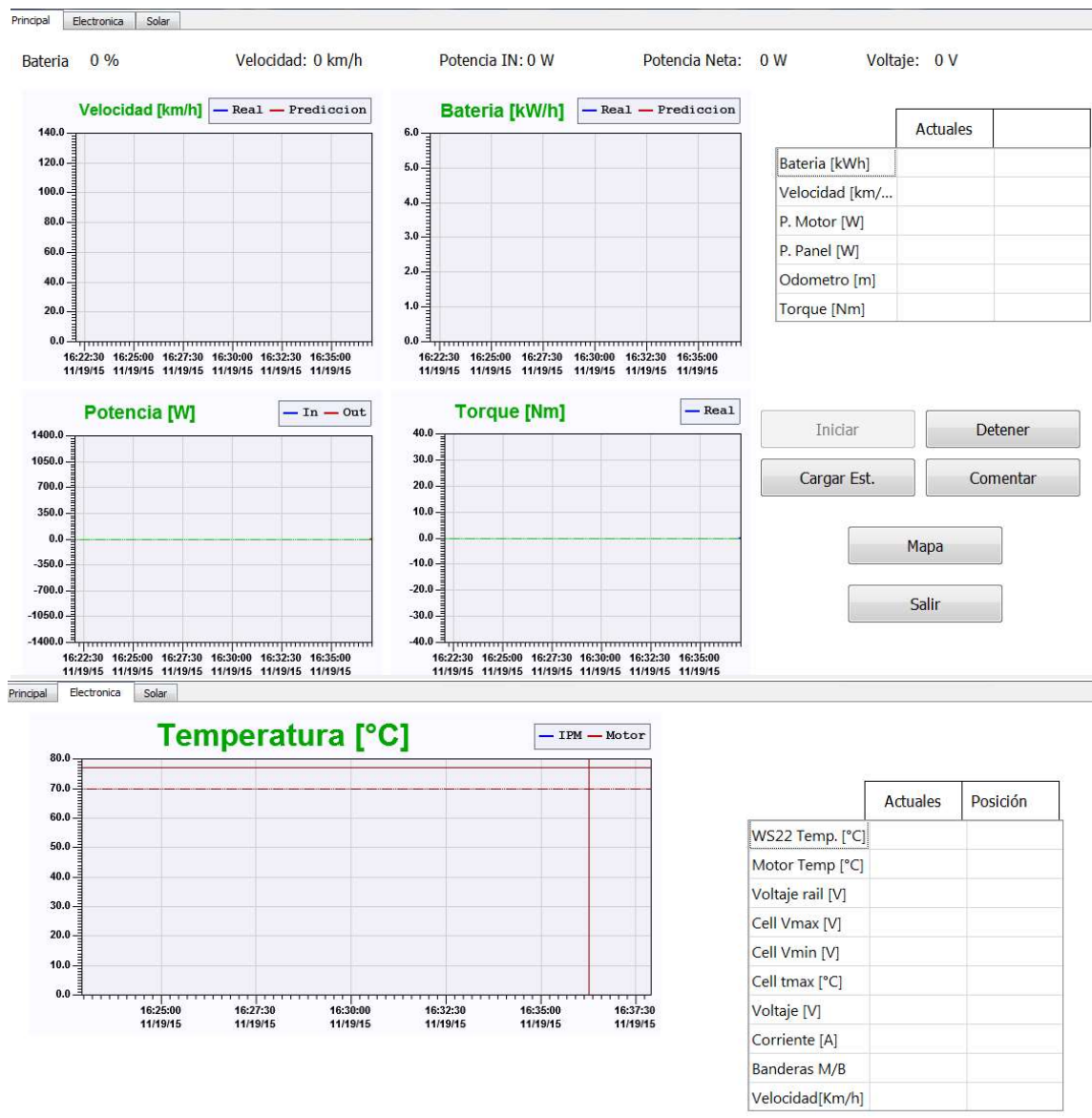

Figure 4.17: Primavera2 Qt-based proposed GUI design for Bridgestone World Solar Challenge 2015 race

the competition, to be able to maintain the average speed of the vehicle in the last days of race. Also, SPC allowed to avoid specific consumption peaks in the middle of the competition, where Strong frontal winds and failures in the energy production of the solar panel were found. Although SPC is a secondary variable (which did not derive directly from physical magnitudes that were measured in the vehicle), it was of great relevance for the competition. This variable could not be found during the analysis of the method in the case study, but during the period of competition. Then, a cycle

of analysis is required within the method to find secondary variables, from those that were qualified within the FDM.

In conclusion, the variables that were used for the vehicle monitoring GUI were constructed with variables with high VRI values obtained with the application of the method. Although the variables were constructed in accordance with the results of the method, variables that were not monitored directly from the vehicle were not included but were calculated and that had to be operated manually during the competition.

#### 4.2.6.2 Performance comparison against *Primavera 2* and proposed objectives

The solar vehicle arrived satisfactorily to the city of Adelaide, with a racing time of 46hours and 19minutes, with an official distance traveled of 3022km and a position of 9<sup>th</sup> in the general classification for Challenger class vehicle. By itself, the results of competition clearly show that the proposed objectives were met. Then, for further analysis, the mission definition elements are retrieved by taking information from the 4.2 section.

*The objective of the competition is to complete the route between the two cities (Darwin - Adelaide) taking advantage of the energy captured only from the sun, through Solar Electric Vehicle (SEV) Photovoltaic array.* The solar vehicle required 6 days and two and a half hours to complete the race. Originally, from the strategy team, it was defined that, to win the race it should take about 5 race days to complete the journey. The deviation in one day in race time was due to problems occurred during the second day of competition (in which the vehicle was off the road due to strong cross winds), and problems with the solar panel that reduced the generation of the vehicle and hence, the average speed of the vehicle.

*The vehicle can only run within the official competition schedule, which is from 8:00 AM to 5:00 PM (Darwin Time - Solar Time).* The solar vehicle received no penalties with respect to the camping stop time delays. To ensure the arrival at suitable camping sites, the approved 10-minute time window was used.

*A deadline of 50 hours is established to complete the race which defines time limits to arrive at control stops. Otherwise, the contestant fails and is forced to tow the vehicle to the city of Adelaide.* It was not necessary to tow the vehicle. The official time of competition was less than the maximum allowed time.

*Arrive to city of Adelaide as fast as possible, within ten first teams.* The vehicle arrived in 9<sup>th</sup>

position within the overall standings.

*Arrive to city of Adelaide in a safe way for pilot and support team.* Despite an accident took the vehicle off the road, both the driver and the vehicle did not suffer serious damage, so it was possible to resume the race after a mechanical revision of the vehicle and the changing of the pilot. The vehicle experienced no problems that prevented it from reaching the goal by its own means.

## Chapter 5

# Conclusions

The method allowed to analyze a large amount of information from the definition of a mission, such as objectives, success criteria, basic functions of the technical system and restrictions, elements that are generally not taken into account when designing a variable monitoring system. Starting from these elements, it is possible to concentrate the analysis effort in elements that if they impact the objectives that were raised for the mission, and it avoids to include data or information that is irrelevant, independently that apparently is important. Despite this, the process of collecting variables, as well as their qualification, was complicated due to the large amount of information to be processed without some type of systematization.

The analysis was done in five defined steps. In the first step of the method, strategic-relevant information about the capabilities and constraints of the mission was found, focusing on the definition of the mission and the main objective.

Then, basic functions were generated to fulfill the objective of the mission, as well as to seek a strategy for the qualification of these basic functions. In this step of the method, the link between mission information that is usually presented in a fuzzy form, was made, becoming concrete information and, into functions that can be break down. It must be taken into account that the execution of the tasks are performed in time intervals (ranging from *30minutes* to *6hours*, in a cyclic way), and can be grouped into OS. In addition, a strategy based on finding identical subsystems behaviors, even during different time intervals) were found to reduce the number of operational stages of a system up to 40% (from 7 to 3 OS), facilitating their analysis (by reducing the amount of OS) and avoiding unnecessary redundancies on the monitoring of information (3 redundant OS were found and avoided).

The fourth step allowed for the extraction of variables from the technical system, using exist-

ing methodologies for system analysis based on functional structures. Thus, the interaction between subsystems becomes explicit and more hidden information could be extracted by the proposed criteria of including additional instrumentation (sensors) based on the analysis of relevance, impact and importance, given the main objective fulfillment.

In the fifth step, having as inputs both, the basic functions of strategic level and the variables obtained at technical level, they were put to the consideration of the operator, who found relations between both, using a concrete scale of easy use. At the end, applying a threshold adjust value of  $K_{Th} = 0.7$ , configurable by the operators, with threshold values from  $Th_{OS'_2} = 0.0958$  to  $Th_{OS'_3} = 0.1208$ . Those variables with greater relative weighting between operational states (a mean of 27 for each OS, Equivalent to 15% of the whole set of variables), were considered relevant to the fulfillment of the mission objective, and therefore, selected to be part of the system graphical monitoring interface.

The method allowed to combine both the analysis and selection of information with the operators' knowledge, expressed in scoring of information relevance, based on an organized inductive reasoning.

*Primavera 2*, The solar vehicle project was a suitable validation and testing platform for the implementation of the method, as its a CS, monitored remotely through a large amount of data transmitted (500Bytes per second) radio link and HMI interface by a strategy team of expert operators; under conditions similar to those of a control room of an industrial or aerospace systems.

For the case study, on one hand, 168 variables were identified. Then, after applying FDM, the set was reduced to 30 selected variables, reducing the analysis to a 18% of the full amount of information. On the other hand, 7 operational stages were simplified to 4 final operational stages. This reduction of 43% enabling another component of the simplification of the analysis.

During the Race, 4 variables were included, which were not analyzed by FDM. FDM is based on the analysis of magnitudes that come directly from the system, without taking into account those variables, that can be obtained from these magnitudes (that is, the method does not contemplate the explicit inclusion of secondary variables), moreover, if they are not evident or recognizable under the context of the mission.

Some environmental variables (such as Relative Humidity, Temperature, Wind speed/direction) were important to support the strategist's decisions. However, these variables were not originally taken into account in the FDM because they were not part of the race strategy calculations. This was mainly because of the difficulty to automatically monitor these variables, and consequently making

impossible its inclusion in the main HMI, as well as being able to correlate them with the other system variables directly.

From the point of view of Knowledge Management, the method take advantage of the knowledge of the operators, by relating the variables to the tasks that must be performed to ensure that the mission is executed in a satisfactory way (100% of accomplishment of success criteria for the solar vehicle), using the operator judgment and helping him with additional information which is extracted systematically, from the point of view of the mission, as well as the process.

Mission Information can be preserved in the form of FDM matrix, by allowing operators to find relationships between the functions required to fulfill the mission's objectives and to do it explicitly and systematically. These experiences may consolidate a set of information that can be available to be used in successive missions.

VRI values were found to be significantly higher for the predominant operating state of the mission,  $OS'_3$ , up to 78.5% higher than  $OS'_4$ . Then, the weighting values of the variables are consistent with the importance of the operating state. This indicates that those variables that can serve an operational state, may not do so for another. In the case of the CS in a not working state (idle, were all monitoring devices and subsystems were shut down), the method lowered the variables VRI, even, returning zero values.

Then, as the whole set of selected variables changes their VRI values among OS, the relevance of the variables is dynamic, and can not be observed in telemetry or monitoring systems where the variables presented are static.

Looking at the mission as a whole, it was found that there are certain variables (29, equivalent to 15.4%, on  $OS'_3$ ) that have a higher score not only within an operational state, but among all the operational states of the process. In this way, main mission variables can be identified. That operating state, where the variables receive higher relative scores, will be the main operating state of the mission.

In terms of the case study, high weighting values were identified for the most significant operating state ( $OS'_3$ ), not only in the main mission variables, but for those variables that have lower VRI.

### **5.0.7 Recommendations and Further research**

With the method as a guideline, the selection of the information, as well as its classification, is done objectively. Better information is available instead of a large amount of information (one of the fundamental principles of the Knowledge Management, concerning information sharing and information

quality)[Keller and Staelin, 1987, Quintas et al., 1997]. When the operators carry out the subsystems analysis of the CS, as well as the mission elements (in tools like the FDM), their knowledge and how they relate the process functions and the systems itself, can be obtained as insights. This is the main input for Knowledge Based Systems design.

From the functional analysis, the process interaction with the environment or with some external agent must be taken into account; Such interaction is expressed through variables that can not necessarily be monitored, the functional analysis must be extended beyond the process boundaries. Also, shortcomings were identified in the identification of variables that do not come directly from the functional analysis of the system, and that should be calculated or monitored indirectly. Then, the method is not robust with respect to the inclusion of variables that can not be extracted directly from the system, a situation that is not covered in any of the proposed steps.

As future work, it is proposed to implement the method using software tools, which allows the weighing of the variables in a simpler and faster way, especially in processes of greater complexity, as it is expected that the number of variables increases in a proportional way in highly complex systems, which makes application of the method impractical using non automated platforms. Also, combining it with ergonomic information deployment strategies, dynamic interfaces can also be created, depending on the operational state of the process.

In order to analyze the case study, no previous information was required (as design and strategy files), regarding the competition of the first solar vehicle. Within the Operators' team, there were two members of the *Primavera 1* with racing experience. Further validation is required for other case studies, it can not be said that applying the method with expert operators in their fields but without experience in similar operations can yield satisfactory results. It would be expected that experienced operators in similar situations can accurately determine the Variable Relevance Indicator (VRI). The validation of this qualification must be done after repeating the mission. Although a VRI values trend was found in the case study, and it would be expected to be maintained for other analysis, further testing in other contexts should be done to ratify this trend. In this way, the method can be used to identify and even weight the importance of the operating states of the system.

# References

- National Aeronautics and Space Administration Johnson Space Center. Mission control, houston: Mission control center and flight operations. 2006.
- Sarabjot S Anand, David A Bell, and John G Hughes. Edm: A general framework for data mining based on evidence theory. *Data & Knowledge Engineering*, 18(3):189–223, 1996.
- Glen E Baer, Raymond J Harvey, Mark E Holdridge, Richard K Huebschman, and Elliot H Rodberg. Mission operations. *Johns Hopkins APL technical digest*, 20(4):511–521, 1999.
- Alexandra Boulgakov. *Sunswift IV strategy for the 2011 World Solar Challenge*. PhD thesis, Citeseer, 2012.
- Catherine M Burns and John Hajdukiewicz. *Ecological interface design*. CRC Press, 2013.
- École Polytechnique Fédérale de Lausanne Chair of Combinatory Geometry. Cayley’s theorem and prufer codes. sep 2016. URL <http://dgc.epfl.ch/files/content/sites/dgc/files/users/andres/GT2015/CayleyPrufer.pdf>.
- North American Electric Reliability Corporation. Glossary of terms used in nerc reliability standards. sep 2014. URL [https://library.e.abb.com/public/f091b8ae9dec300f85257d6500660234/pa\\_Stand\\_Glossary-2.pdf](https://library.e.abb.com/public/f091b8ae9dec300f85257d6500660234/pa_Stand_Glossary-2.pdf).
- Marc Demarest. Understanding knowledge management. *Long range planning*, 30(3):321374–322384, 1997.
- Jasbir S Dhaliwal and Izak Benbasat. The use and effects of knowledge-based system explanations: theoretical foundations and a framework for empirical evaluation. *Information systems research*, 7(3):342–362, 1996.

- Technical F1 Dictionary. Technical f1 dictionary. 2015. URL [http://www.formula1-dictionary.net/race\\_control.html](http://www.formula1-dictionary.net/race_control.html).
- Rose Dieng, Olivier Corby, Alain Giboin, and Myriam Ribiere. Methods and tools for corporate knowledge management. *International journal of human-computer studies*, 51(3):567–598, 1999.
- Robert A Divine. *The sputnik challenge*. Oxford University Press, 1993.
- Computer Desktop Encyclopedia. Yourdictionary.com, mission control - computer definition. may 2015. URL <http://www.yourdictionary.com/mission-control>.
- Jie Geng, Chuan Lv, Dong Zhou, and Zili Wang. A mission execution decision making methodology based on mission-health interrelationship analysis. *Computers & Industrial Engineering*, 95:97–110, 2016.
- Shell Global. Shell eco-marathon. May 2015. URL <http://www.shell.com/global/environment-society/ecomarathon.html>.
- Nicholas J Gotelli et al. *A primer of ecology*. Sinauer Associates Sunderland, MA, 1995.
- Antony Hilliard and Greg A Jamieson. Ecological interface design for solar car strategy: From state equations to visual relations. In *SMC*, pages 139–144, 2007.
- Antony Hilliard and Greg A Jamieson. Winning solar races with interface design. *Ergonomics in Design: The Quarterly of Human Factors Applications*, 16(2):6–11, 2008.
- Eric Horvitz and Matthew Barry. Display of information for time-critical decision making. In *Proceedings of the Eleventh conference on Uncertainty in artificial intelligence*, pages 296–305. Morgan Kaufmann Publishers Inc., 1995.
- Siu Cheung Hui and G Jha. Data mining for customer service support. *Information & Management*, 38(1):1–13, 2000.
- Solar Impulse. Mission control center: In search of the most suitable patterns for the round-the-world route, several thousand flights have been simulated since 2005, taking account of varying meteorological conditions.
- Horváth Imre. Comparison of three methodological approaches of design research. *Guidelines for a Decision Support Method Adapted to NPD Processes*, 2007.

- John F. Kennedy Presidential Library and Museum. Jfk in history, space program. february 2017. URL <https://www.jfklibrary.org/JFK/JFK-in-History/Space-Program.aspx>.
- Stephen B Johnson. Goal-function tree modeling for systems engineering and fault management. In *AIAA Infotech@ Aerospace (I@ A) Conference*, page 4576, 2013.
- Kevin Lane Keller and Richard Staelin. Effects of quality and quantity of information on decision effectiveness. *Journal of consumer research*, 14(2):200–213, 1987.
- CF Kirschman and Georges M Fadel. Classifying functions for mechanical design. *Journal of mechanical design*, 120(3):475–482, 1998.
- Peter Krumhauer. *Rechnerunterstützung für die Konzeptphase der Konstruktion: ein Beitrag zur Entwicklung eines Programmsystems für die Lösungsfindung konstruktiver Teilaufgaben*. Technische Universität Berlin, 1974.
- Wiley J Larson and James Richard Wertz. Space mission analysis and design. Technical report, Microcosm, Inc., Torrance, CA (US), 1992.
- Shu-hsien Liao. Knowledge management technologies and applications—literature review from 1995 to 2002. *Expert systems with applications*, 25(2):155–164, 2003.
- Morten Lind. Plant modelling for human supervisory control. *Transactions of the Institute of Measurement and Control*, 21(4-5):171–180, 1999.
- Ivan Litvaj and Dana Stancekova. Decision-making, and their relation to the knowledge management, use of knowledge management in decision-making. *Procedia Economics and Finance*, 23:467–472, 2015.
- Louis McCarthy, Josh Pieper, Aaron Rues, and Cheng Hsiao Wu. Performance monitoring in umr’s solar car. *IEEE Instrumentation & Measurement Magazine*, 2000.
- NASA. New horizons: The first mission to the pluto system and the kuiper belt. 2016. URL [https://www.nasa.gov/mission\\_pages/newhorizons/overview/index.html](https://www.nasa.gov/mission_pages/newhorizons/overview/index.html).
- Joint Chiefs of Staff, editor. *Department of Defense dictionary of military and associated terms: with the NATO, CENTO and IADB glossaries incorporated*. Joint Chiefs of Staff, 1979. URL <http://www.dtic.mil/dtic/tr/fulltext/u2/734441.pdf>.

- K Otto and K Wood. Product design: Techniques in reverse engineering, systematic design, and new product development. 2001.
- Gerhard Pahl and Wolfgang Beitz. *Engineering design: a systematic approach*. Springer Science & Business Media, 2013.
- John A Pearce and Fred David. Corporate mission statements: The bottom line. *The Academy of Management Executive*, 1(2):109–115, 1987.
- Charles Perrow. *Normal accidents: Living with high risk technologies*. Princeton University Press, 2011.
- V.L. Pisacane. *Fundamentals of Space Systems*. Applied Physics Laboratory series in science and engineering. Oxford University Press, 2005. ISBN 9780195162059. URL <https://books.google.com.co/books?id=uTwb7d8PTXMC>.
- Laura Pomponio and Marc Le Goc. Reducing the gap between experts' knowledge and data: The tom4d methodology. *Data & Knowledge Engineering*, 94:1–37, 2014.
- Cambridge University Press. mission definition. In *Cambridge Dictionary*. Cambridge University Press, 2015.
- Paul Quintas, Paul Lefere, and Geoff Jones. Knowledge management: a strategic agenda. *Long range planning*, 30(3):322385–391, 1997.
- Jens Rasmussen. *Information processing and human-machine interaction. An approach to cognitive engineering*. North-Holland, 1986.
- D Roche, A Schinks, J Storey, C Humphris, and M Guelden. *Speed of Light: The 1996 World Solar Challenge*. Photovoltaics Special Research Centre, School of Electrical Engineering,, 1997.
- Peter G Roma, Steven R Hursh, Robert D Hienz, Zabecca S Brinson, Eric D Gasior, and Joseph V Brady. Effects of autonomous mission management on crew performance, behavior, and physiology: insights from ground-based experiments. In *On orbit and beyond*, pages 245–266. Springer, 2013.
- Thomas L Saaty. Decision making with the analytic hierarchy process. *International journal of services sciences*, 1(1):83–98, 2008.

- K Schilling. Control aspects of interplanetary spacecraft—an introduction to the cassini-huygens mission. *Control Engineering Practice*, 3(11):1599–1601, 1995.
- Science Learning Hub - The University of Waikato. Solar car sketch. march 2010. URL <https://www.sciencelearn.org.nz/images/2182-solar-car-sketch>.
- Sheldon Shen. Knowledge management in decision support systems. *Decision Support Systems*, 3(1):1–11, 1987.
- Thomas B Sheridan. *Telerobotics, automation, and human supervisory control*. MIT press, 1992.
- Yasuo Shimizu, Yasuyuki Komatsu, Minoru Torii, and Masato Takamuro. Solar car cruising strategy and its supporting system. *JSAE review*, 19(2):143–149, 1998.
- Robert Shishko and Robert Aster. Nasa systems engineering handbook. *NASA Special Publication*, 6105, 1995.
- Liang Sim, Mary L Cummings, and Cristin A Smith. Past, present and future implications of human supervisory control in space missions. *Acta Astronautica*, 62(10):648–655, 2008.
- David Skyrme. Knowledge management: making sense of an oxymoron. *Management insights*, 22, 1997.
- Tom Snooks. The quiet achiever, bp solar car crossing australia: The little car that could. may 2015. URL [http://www.snooksmotorsport.com.au/solartrek/Solar\\_Trek/Solar\\_Trek\\_The\\_Vehicle.htm](http://www.snooksmotorsport.com.au/solartrek/Solar_Trek/Solar_Trek_The_Vehicle.htm).
- C Sollazzo, J Rakiewicz, and RD Wills. Cassini-huygens: Mission operations. *Control Engineering Practice*, 3(11):1631–1640, 1995.
- South Australian Tourism Commission - The Motor Sport Group. Bridgestone world solar challenge overview. jauary 2015. URL [https://www.worldsolarchallenge.org/page/view\\_by\\_id/76](https://www.worldsolarchallenge.org/page/view_by_id/76).
- South Australian Tourism Commission - The Motor Sport Group. Bridgestone world solar challenge road map. jauary 2017. URL [https://www.worldsolarchallenge.org/event-information/route\\_map](https://www.worldsolarchallenge.org/event-information/route_map).

- Rudi Studer, V Richard Benjamins, and Dieter Fensel. Knowledge engineering: principles and methods. *Data & knowledge engineering*, 25(1-2):161–197, 1998.
- Karl Erik Sveiby. *The new organizational wealth: Managing & measuring knowledge-based assets*. Berrett-Koehler Publishers, 1997.
- Zahari Taha, Rossi Passarella, Jamali Md Sah, and Nasrudin Bin Abd Rahim. A review on energy management system of solar car. In *The 9th asia pacific industrial engineering & management systems conference*, pages 3–5. Citeseer, 2008.
- Zahari Taha, Rossi Passarella, Nasrudin Abd Rahim, Aznizar Ahmad-Yazid, and Jamali Md Sah. Development of a solar car. *Asia Pacific Industrial Engineering and Management Society*, 2010a.
- Zahari Taha, Rossi Passarella, Hui Xin How, Jamali Md Sah, Norhafizan Ahmad, Raja Ariffin Raja Ghazilla, and Jen Hwa Yap. Application of data acquisition and telemetry system into a solar vehicle. In *Computer Engineering and Applications (ICCEA), 2010 Second International Conference on*, volume 1, pages 96–100. IEEE, 2010b.
- Jay Trimble, Joan Walton, and Harry Saddler. Mission control technologies: A new way of designing and evolving mission systems. In *SpaceOps 2006 Conference*, page 5544, 2006.
- TU Delft. Nuna7 - world solar challenge 2013: Lees hier het laatste nieuws over de avonturen en prestaties van het nuon solar team. *Delft University of Technology*, 2013. URL <http://www.tudelft.nl/actueel/laatste-nieuws/nuna7-world-solar-challenge-2013/>.
- Omkarprasad S Vaidya and Sushil Kumar. Analytic hierarchy process: An overview of applications. *European Journal of operational research*, 169(1):1–29, 2006.
- IJ Van Baar, Z El Bakkali, JJ Van Daltsen, ED Van der Schrier, and LGJ Vogelzang. Building a gui for nuna’s mission control. 2014.
- Maria Antonietta Viscio, Nicole Viola, Roberta Fusaro, and Valter Basso. Methodology for requirements definition of complex space missions and systems. *Acta Astronautica*, 114:79–92, 2015.
- Simon Watkins and Clive Humphris. Solar vehicles: The challenge of maximum speed from minimal power. In Fluids Engineering Division American Society of Mechanical Engineers ASME, editor, *Proceedings of ASME FEDSM’02*, volume 2 of *FEDSM2002-31245*, pages 1009–1014. ASME, July 2002.

- Christopher Webster, Nija Shi, Sue Blumenberg, Irene Smith, Sylvia Lin, Benson Hong, Adam Crume, and Peter Tran. User-driven collaboration for nasa mission control. In *System Science (HICSS), 2012 45th Hawaii International Conference on*, pages 702–711. IEEE, 2012.
- Christopher D Wickens, Justin G Hollands, Simon Banbury, and Raja Parasuraman. *Engineering psychology & human performance*. Psychology Press, 2015.
- Karl M Wiig. Knowledge management: Where did it come from and where will it go? *Expert systems with applications*, 13(1):1–14, 1997.
- Karl M Wiig, Robert de Hoog, and Rob Van Der Spek. Supporting knowledge management: a selection of methods and techniques. *Expert systems with applications*, 13(1):15–27, 1997.
- Carsten Wittenberg. A pictorial human–computer interface concept for supervisory control. *Control Engineering Practice*, 12(7):865–878, 2004.
- Kristin L Wood. Functional analysis: A fundamental empirical study for reverse engineering, benchmarking, and redesign. *Proceedings of the 1997 Design Engineering Technical Conferences*, 1997.
- D.D. Woods, J.F. O’Brien, and L. F. Hanes. Human factors challenges in process control: The case of nuclear power plants. In Gavriel Salvendy, editor, *Handbook of human factors*, pages 1725–1770. Wiles, New York, 1987.
- Zita Zoltayné Paprika. Knowledge management support in decision making—its title in hungarian: A tudásmenedzsment támogatása a döntéshozatalban. *Archive of the CUB Institute of Business Economics*, 2001.



## Appendix A

# Space Mission Analysis and Design - SMAD Example: *FireSat*

*Because forest fires have an Increasing Impact on recreation an commerce and ever higher public visibility, the United States needs a more effective system to Identify and monitor them. In addition, It would be desirable (but not required) to monitor forest fires for other nations; collect statistical data on fire outbreaks, spread, speed, and duration; and provide other forest management data. Ultimately, the Forest Service's fire-monitoring office and rangers In the field will use the data. Data flow and formats must meet the needs of both groups without specialized training and must allow them to respond promptly to changing conditions.*[Larson and Wertz, 1992]

From the statement for the *FireSat* mission, the authors established main and secondary objectives as it follows:

**FireSat Primary Objective:**

To detect, Identify, and monitor forest fires throughout the United States, Including Alaska and Hawaii, In near real time.

**FireSat Secondary Objectives:**

1. To demonstrate to the public that positive action Is underway to contain forest fires.
2. To collect statistical data on the outbreak and growth of forest fires.
3. To monitor forest fires for other countries.
4. To collect other forest management data.

[Larson and Wertz, 1992]

Top level mission requirements for the *FireSat* Mission example. is shown in the Table. A.1.

Table A.1: Examples of Top-Level Mission Requirements for *FireSat* Mission study case. We typically subdivide these top-level requirements into more specific requirements applicable to specific space missions.[Larson and Wertz, 1992]

TOP LEVEL MISSION REQUIREMENTS		
MISSION NAME	<i>FireSat</i>	
<b>Mission Statement</b>	<i>Because forest fires have an Increasing Impact on recreation an commerce and ever higher public visibility, the United States needs a more effective system to Identify and monitor them. In addition, It would be desirable (but not required) to monitor forest fires for other nations; collect statistical data on fire outbreaks, spread, speed, and duration; and provide other forest management data. Ultimately, the Forest Service's fire-monitoring office and rangers In the field will use the data. Data flow and formats must meet the needs of both groups without specialized training and must allow them to respond promptly to changing conditions.</i>	
<b>Mission Primary Objectives</b>	<i>To detect, Identify, and monitor forest fires throughout the United States, Including Alaska and Hawaii, In near real time.</i>	
<b>Mission Secondary Objectives</b>	<ol style="list-style-type: none"> <li><i>1. To demonstrate to the public that positive action Is underway to contain forest fires.</i></li> <li><i>2. To collect statistical data on the outbreak and growth of forest fires.</i></li> <li><i>3. To monitor forest fires for other countries.</i></li> <li><i>4. To collect other forest management data.</i></li> </ol>	
REQUIREMENT	FACTORS	MISSION VALUES (GOALS)
FUNCTIONAL		
Performance	Primary Objective, payload size, orbit, pointing	4 temperature levels, 30m resolution, 500m location accuracy
Coverage	Orbit, swat width, number of satellites, schedulling	Daily coverage of 750M acres within continental US
Responsiveness	Communication architecture, processing delays, operations	Send registered mission data within 30 minutes up to 50 users
Secondary mission		4 temperature levels for pest management
OPERATIONAL		
Mission Duration	Experiment or operations, level of redundancy, altitude	Mission operational at least 10 years
Availability	Level of redundancy	98% excluding weather, 3-day maximum outage
Survivability	Orbit, hardening, electronics	Natural enviroment only
Data distribution	Communication architecture	Up to 500 fire monitoring offices, +2000 rangers worldwide (maximum 100 simultaneous users)
Data content and format	User need, level and place of processing, payload	Location and extent of fire on any 12 map bases, average temperature for each 30m2 grid
CONSTRAINTS		
Costs	Manned flight, number of spacecraft, size and complexity, orbit	Less than US\$20M per year +R&D
Schedule	Technical readiness, program size	Initial Operating capability within 5 years, final operating capability within 6 years
Regulations/Political	Law and policy, sponsorship, whether international program,	NASA Mission, responsible for public demand for action
Environment	Orbit, lifetime	Natural
Interfaces	Level of user and operator infrastructure	Communication, relay and interoperable through NOAA ground stations
Development constraints	Sponsoring organization	Launch on STS or expendable, no unique operations at data distribution nodes

Firesat mission architecture diagram is shown in Fig.A.1.

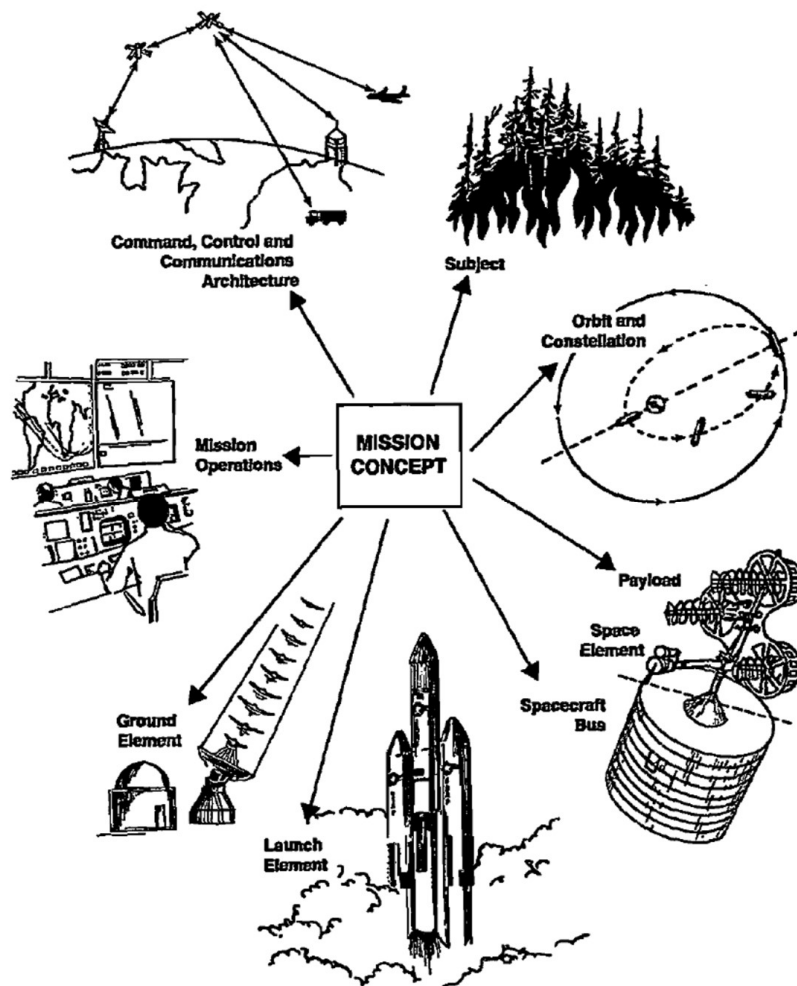

Figure A.1: Space Mission Architecture for Operator Requirements, end User Requirements and Developer Requirements for *FireSat* Study Case. Taken from [Larson and Wertz, 1992]



## Appendix B

# Bridgestone World Solar Challenge 2015

## Regulations

The following are some highlighted regulations from the Bridgestone World Solar Challenge 2015, regarding to Basic Functions Analysis of the Case Study.

### **2.4 Construction.**

**2.4.1** Solar EVs must be constructed or adapted to protect, as far as is reasonably possible, the occupants in the event of collision or roll-over. Steps should be taken to ensure that the structure (such as the solar collector), components or accessories will not impinge on the occupant space in a crash.

**2.4.2** Occupants of Solar EVs, whilst seated in a normal driving position, must be enclosed in a safety cage capable of protecting them from a (hypothetical) drop of 1 metre onto a concrete floor, from every orientation. Forces due to impact are typically calculated by  $F = E/s$ , where E is the kinetic energy of the object prior to the collision and s is the distance travelled after impact. Previously we specified a force of  $5mg$ , where  $g = \frac{9.8m}{s^2}$ . For a  $250kg$  Challenger Class Solar EV (with driver), this is equivalent to stopping in  $0.2m$  from a  $1m$  drop onto concrete or stopping in  $4.1m$  from speed  $\frac{20m}{s}$

### **2.5 Occupant Ventilation and Hydration.**

**2.5.1** Adequate ventilation and drinking water must be provided to all occupants. Details of the ventilation system must be described in the General Specification Document. Ambient temperature during the World Solar Challenge can be over  $45^{\circ}C$ , and the interior of a Solar EV can be  $10^{\circ}C$  above the ambient temperature. Ventilation, together with adequate hydration, is particularly important to allow Solar EV occupants to maintain a healthy body temperature.

**2.6.2** The Solar EV must have rear vision systems that enable the driver to see the shaded areas shown from the normal driving position with the seatbelt fastened (UNECE Regulation 46, Section 15).

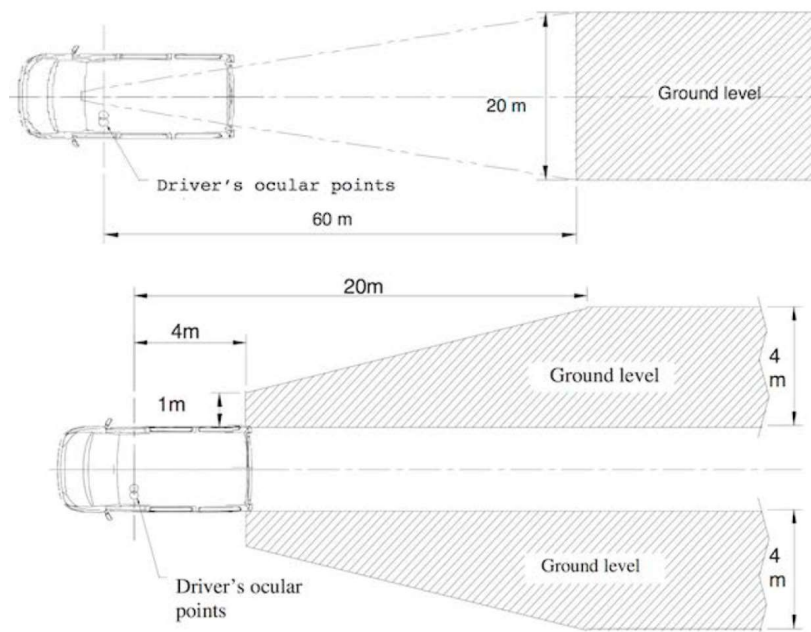

Figure B.1: Mandatory rear vision areas for solar EV. Taken from [South Australian Tourism Commission - The Motor Sport Group., 2017]

**2.6.5** Windows must have an optical transmittance not less than 75% (UNECE Regulation 43).

## 2.7 Seats.

**2.7.5** For Challenger Class and Cruiser Class Solar EVs, each occupant's heels must be below the seating reference point, and the angle between the shoulders, hips and knees must be not less than 90 degrees.

**2.7.6** Seatbelts must be fitted for each seating position. Seatbelts must be compliant with UNECE Regulation 16 or US FMVSS 571.209 (or equivalent) and display the appropriate compliance marking.

## 2.9 Brakes

Braking requirements for Solar EVs are based on UNECE Regulation 13-H.

**2.9.1** The Solar EV must be equipped with two independent mechanical braking systems, so that if one system fails the other can still bring the Solar EV to a halt. A regenerative braking system does

not contribute to the requirement of Regulation 2.9.1.

**2.9.5** Braking must not cause the Solar EV to yaw.

## **2.10 Steering**

**2.10.1** The steering system must have minimal backlash, and be designed with adequate strength and stiffness to assure good driving control in all circumstances.

**2.10.6** Steering shafts must be designed so that they will not spear the driver in a crash. A collapsible boss is an acceptable way to reduce steering wheel impacts.

## **2.16 Vehicle Control**

**2.16.1** Any cruise control function must automatically deactivate when the brake or accelerator pedal is operated, and when the main switch is turned off.

## **2.19 Electrical**

- Electrical requirements are based on Section 5 of UNECE Regulation 100.
- The term high voltage means more than 60 V dc or more than 30V<sub>rms</sub> AC.

**2.19.1** All high-voltage parts must be protected by covers or protection grills that are reliably secured and marked with the approved high voltage symbol.

**2.19.2** Covers that can be reached by Solar EV occupants while driving must be designed to exclude objects larger than 1 mm diameter (Ingress Protection rating IPXXD).

## **2.20 Electrical Safe State**

**2.20.1** The Solar EV must have a Safe State which minimises the risk of electrical fire and electric shock to occupants, team members, emergency response personnel or bystanders.

## **2.21 Energy sources**

**2.21.1** For Challenger Class and Adventure Class Solar EVs, solar irradiation received directly by the Solar EV is the only external energy source that may be used by the Solar EV.

**2.21.6** For Challenger Class and Cruiser Class Solar EVs, if the solar collector uses photovoltaic cells then the allowable area of photovoltaic cells is:

- not more than 6.000 square metres for Solar EVs using only silicon photovoltaic cells

- not more than 3.000 square metres for Solar EVs using only GaAs photovoltaic cells.

Challenger Class and Cruiser Class Teams wishing to use other types of photovoltaic cells, a mix of photovoltaic cell types, or other types of solar collector, must contact the Organiser.

**2.22.9** For Challenger Class and Adventure Class Solar EVs, if the energy storage system is a secondary electrochemical battery then the sum of the nominal cell masses, as specified and endorsed by the cell manufacturer and approved by the Chief Energy Scientist, may not exceed the following limits:

- Li-ion 20.000kg
- Li-Polymer 20.000kg
- LiFePO4 40.000kg
- Ni-MH 70.000kg
- Pb-Acid 125.000kg

### **2.23 Roadworthiness**

**2.23.1** Each Team is responsible for the roadworthiness of its Solar EV. By submitting an entry, the Entrant declares the Solar EV's integrity and suitability for the Event.

### **3.7 Communication**

**3.7.1** Every Solar EV must have means of two-way voice radio communication with its Rear Escort Vehicle when driving.

### **3.20 Tracking**

**3.20.1** Each Solar EV will be required to carry a data logging and tracking device provided by the Organiser. Provision must be made for a box, maximum dimensions  $l = 200\text{mm} \times w = 150\text{mm} \times h = 100\text{mm}$ , to be fitted in the Solar EV. The upper face of the box will require a minimum 1.6 steradian view of the sky through a minimum 125mm diameter circular window made of a radio-transparent material. The mass of the unit will not exceed 5kg.

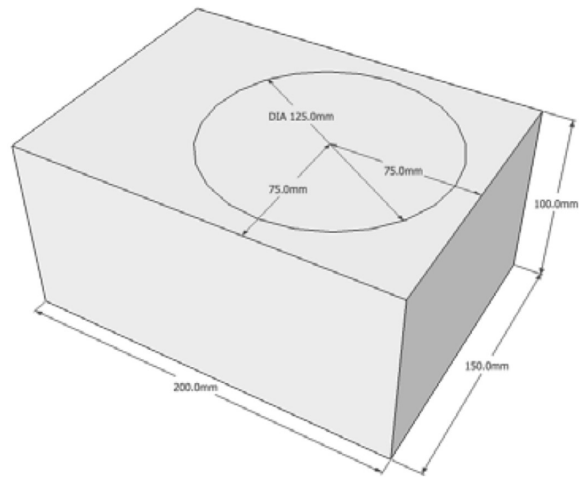

Figure B.2: Tracking device specifications. Taken from [South Australian Tourism Commission - The Motor Sport Group., 2017]



## **Appendix C**

# **Function to Data Matrix Analysis for Primavera 2 Solar Car - Bridgestone World Solar Challenge 2015**

FLOWS	VARIABLE	ATTRIBUTES				BASIC FUNCTIONS										Variable Relevance OS'n wfa
		alpha	Beta	Gamma	Delta (Hz)	To maintain Structural Integrity	To provide Life Support	To store Energy	To recover kinetic energy	To collect energy from the sun	to perform driving actions	to send vehicle data to crew	to calculate speed setpoint			
						FU4	FU5	FU7	FU9	FU10	FU12	FU13	FU14			
						0,25	0,25	0,16666667	0,08333333	0,08333333	0,08333333	0,04166667	0,04166667	0,04166667		
f4-f11	v1 Battery pack voltage & current					0	0	0	0	0	0	0	0	0,000		
f4-f11	v2 Battery Voltage (mV)	00	V/1000	(90,147)	10	0	0	0	0	0	0	0	0	0,000		
f4-f11	v3 Battery Current (mA)	01	A/1000	(0,30)	10	0	0	0	0	0	0	0	0	0,000		
f4-f11	v4 Pack SOC					0	0	0	0	0	0	0	0	0,000		
f4-f11	v5 SOC (Ah) Shows Ah consumed from the pack. 0 = Full, and counts upwards towards the user-set pack capacity number as Ah are used. Resets to 0 when max cell reaches balance threshold.	00	Ah	(0,40,8)	1	0	0	0	0	0	0	0	0	0,000		
f4-f11	v6 Shows the SOC as a percentage. 100% = full, 0% = empty	10		(0,100)	1	0	0	0	0	0	0	0	0	0,000		
f2-f11	v7 Battery Voltage (mV)	00	V/1000	(90,147)	0	0	0	0	0	0	0	0	0	0,000		
f2-f11	v8 Battery Current	01	A	(0,30)	0	0	0	0	0	0	0	0	0	0,000		
f4-f11	v9 Maximum cell voltage (mV)	00	V/1000	(2,6,4,2)	10	0	0	0	0	0	0	0	0	0,000		
f11-f6	v10 Bus Voltage - DC bus voltage at the controller.	00	V/1000	(90,147)	5	0	0	0	0	0	0	0	0	0,000		
f2-f11	v11 Capacity (mAh)	00	Ah/1000	(0,40,8)	0	0	0	0	0	0	0	0	0	0,000		
f4-f11	v12 Minimum cell voltage (mV)	00	V/1000	(2,5,4,2)	10	0	0	0	0	0	0	0	0	0,000		
f4-f11	v13 Status Flags	10	0	NA	1	0	0	0	0	0	0	0	0	0,000		
f2-f11	v14 Usout(Usout Voltage)	00	V	(90,147)	0	0	0	0	0	0	0	0	0	0,000		
f4-f11	v15 Total pack capacity (Ah)	00	Ah	(0,40,8)	10	0	0	0	0	0	0	0	0	0,000		
f4-f11	v16 Status Flags	10	0	NA	1	0	0	0	0	0	0	0	0	0,000		
f2-f11	v17 BVLB- Battery Voltage Level Reached Flag (0= Usout<UsoutMax, 1=Usout<UsoutMax)	20	V	NA	0	0	0	0	0	0	0	0	0	0,000		
f2-f11	v18 BVLB- Battery Voltage Level Reached Flag (0= Usout<UsoutMax, 1=Usout<UsoutMax)	20	V	NA	0	0	0	0	0	0	0	0	0	0,000		
f4-f11	v19 Battery pack status					0	0	0	0	0	0	0	0	0,000		
f11-f6	v20 Odometer - Distance the vehicle has travelled since reset.	00	m	NA	1	0	0	0	0	0	0	0	0	0,000		
f11-f6	v21 Bus Current - Current drawn from the DC bus by the controller.	00	A	(0,30)	5	0	0	0	0	0	0	0	0	0,000		
f4-f11	v22 Maximum cell temperature (1/10th °C)	00	°C/10	(20,55)	1	0	0	0	0	0	0	0	0	0,000		
f4-f11	v23 Cell number in CMU that is the minimum cell voltage	10	V/1000	NA	10	0	0	0	0	0	0	0	0	0,000		
f4-f11	v24 Cell number in CMU that is the maximum cell voltage	10	V/1000	NA	10	0	0	0	0	0	0	0	0	0,000		
f11-f6	v25 Error Flags	20	0	NA	5	0	0	0	0	0	0	0	0	0,000		
f11-f6	v26 Limit Flags	10	0	NA	5	0	0	0	0	0	0	0	0	0,000		
f11-f6	v27 Vehicle Velocity- Vehicle velocity in metres / second	01	m/s	(16,6, 33,3)	5	0	0	0	0	0	0	0	0	0,000		
f2-f11	v28 In(Input Current)	00	A	(0,4)	0	0	0	0	0	0	0	0	0	0,000		
f2-f11	v29 Uin (Input Voltage)	00	V	(36-141,4)	0	0	0	0	0	0	0	0	0	0,000		
f2-f11	v30 OVT- Overtemperature Flag (0= Temp<95°C, 1=Temp>=95°C)	20	°C	NA	0	0	0	0	0	0	0	0	0	0,000		
f11-f6	v31 Motor Velocity (rpm) Desired motor velocity set point in rpm	01	(pi/30)Ra ds	(850,1100)	4	0	0	0	0	0	0	0	0	0,000		
f4-f11	v32 Balance SOC					0	0	0	0	0	0	0	0	0,000		
f4-f11	v33 Balance SOC (Ah) Shows Ah supplied to the pack since the first cell began balancing. This number will continue to count up until all cells in the pack are balancing, therefore showing the Ah mismatch that has been corrected during this balancing session.	00	Ah	(0,40,8)	1	0	0	0	0	0	0	0	0	0,000		
f4-f11	v34 Minimum cell temperature (1/10th °C)	20	0	NA	1	0	0	0	0	0	0	0	0	0,000		
f4-f11	v35 Cell 0 voltage (mV) +ve -OK, -ve - channel mismatch	00	V/1000	(2,6,4,2)	1	0	0	0	0	0	0	0	0	0,000		
f4-f11	v36 Cell 1 voltage (mV) +ve -OK, -ve - channel mismatch	00	V/1000	(2,6,4,2)	1	0	0	0	0	0	0	0	0	0,000		
f4-f11	v37 Cell 2 voltage (mV) +ve -OK, -ve - channel mismatch	00	V/1000	(2,6,4,2)	1	0	0	0	0	0	0	0	0	0,000		
f4-f11	v38 Cell 3 voltage (mV) +ve -OK, -ve - channel mismatch	00	V/1000	(2,6,4,2)	1	0	0	0	0	0	0	0	0	0,000		
f4-f11	v39 Cell 4 voltage (mV) +ve -OK, -ve - channel mismatch	00	V/1000	(2,6,4,2)	1	0	0	0	0	0	0	0	0	0,000		
f4-f11	v40 Cell 5 voltage (mV) +ve -OK, -ve - channel mismatch	00	V/1000	(2,6,4,2)	1	0	0	0	0	0	0	0	0	0,000		
f4-f11	v41 Cell 6 voltage (mV) +ve -OK, -ve - channel mismatch	00	V/1000	(2,6,4,2)	1	0	0	0	0	0	0	0	0	0,000		
f4-f11	v42 Cell 7 voltage (mV) +ve -OK, -ve - channel mismatch	00	V/1000	(2,6,4,2)	1	0	0	0	0	0	0	0	0	0,000		
f4-f11	v43 Cell 0 voltage (mV) +ve -OK, -ve - channel mismatch	00	V/1000	(2,6,4,2)	1	0	0	0	0	0	0	0	0	0,000		
f4-f11	v44 Cell 1 voltage (mV) +ve -OK, -ve - channel mismatch	00	V/1000	(2,6,4,2)	1	0	0	0	0	0	0	0	0	0,000		
f4-f11	v45 Cell 2 voltage (mV) +ve -OK, -ve - channel mismatch	00	V/1000	(2,6,4,2)	1	0	0	0	0	0	0	0	0	0,000		
f4-f11	v46 Cell 3 voltage (mV) +ve -OK, -ve - channel mismatch	00	V/1000	(2,6,4,2)	1	0	0	0	0	0	0	0	0	0,000		
f4-f11	v47 Cell 4 voltage (mV) +ve -OK, -ve - channel mismatch	00	V/1000	(2,6,4,2)	1	0	0	0	0	0	0	0	0	0,000		
f4-f11	v48 Cell 5 voltage (mV) +ve -OK, -ve - channel mismatch	00	V/1000	(2,6,4,2)	1	0	0	0	0	0	0	0	0	0,000		
f4-f11	v49 Cell 6 voltage (mV) +ve -OK, -ve - channel mismatch	00	V/1000	(2,6,4,2)	1	0	0	0	0	0	0	0	0	0,000		
f4-f11	v50 Cell 7 voltage (mV) +ve -OK, -ve - channel mismatch	00	V/1000	(2,6,4,2)	1	0	0	0	0	0	0	0	0	0,000		
f4-f11	v51 Cell 0 voltage (mV) +ve -OK, -ve - channel mismatch	00	V/1000	(2,6,4,2)	1	0	0	0	0	0	0	0	0	0,000		
f4-f11	v52 Cell 1 voltage (mV) +ve -OK, -ve - channel mismatch	00	V/1000	(2,6,4,2)	1	0	0	0	0	0	0	0	0	0,000		
f4-f11	v53 Cell 2 voltage (mV) +ve -OK, -ve - channel mismatch	00	V/1000	(2,6,4,2)	1	0	0	0	0	0	0	0	0	0,000		
f4-f11	v54 Cell 3 voltage (mV) +ve -OK, -ve - channel mismatch	00	V/1000	(2,6,4,2)	1	0	0	0	0	0	0	0	0	0,000		
f4-f11	v55 Cell 4 voltage (mV) +ve -OK, -ve - channel mismatch	00	V/1000	(2,6,4,2)	1	0	0	0	0	0	0	0	0	0,000		
f4-f11	v56 Cell 5 voltage (mV) +ve -OK, -ve - channel mismatch	00	V/1000	(2,6,4,2)	1	0	0	0	0	0	0	0	0	0,000		
f4-f11	v57 Cell 6 voltage (mV) +ve -OK, -ve - channel mismatch	00	V/1000	(2,6,4,2)	1	0	0	0	0	0	0	0	0	0,000		
f4-f11	v58 Cell 7 voltage (mV) +ve -OK, -ve - channel mismatch	00	V/1000	(2,6,4,2)	1	0	0	0	0	0	0	0	0	0,000		
f4-f11	v59 Cell 0 voltage (mV) +ve -OK, -ve - channel mismatch	00	V/1000	(2,6,4,2)	1	0	0	0	0	0	0	0	0	0,000		
f4-f11	v60 Cell 1 voltage (mV) +ve -OK, -ve - channel mismatch	00	V/1000	(2,6,4,2)	1	0	0	0	0	0	0	0	0	0,000		
f4-f11	v61 Cell 2 voltage (mV) +ve -OK, -ve - channel mismatch	00	V/1000	(2,6,4,2)	1	0	0	0	0	0	0	0	0	0,000		
f4-f11	v62 Cell 3 voltage (mV) +ve -OK, -ve - channel mismatch	00	V/1000	(2,6,4,2)	1	0	0	0	0	0	0	0	0	0,000		
f4-f11	v63 Cell 4 voltage (mV) +ve -OK, -ve - channel mismatch	00	V/1000	(2,6,4,2)	1	0	0	0	0	0	0	0	0	0,000		
f4-f11	v64 Cell 5 voltage (mV) +ve -OK, -ve - channel mismatch	00	V/1000	(2,6,4,2)	1	0	0	0	0	0	0	0	0	0,000		
f4-f11	v65 Cell 6 voltage (mV) +ve -OK, -ve - channel mismatch	00	V/1000	(2,6,4,2)	1	0	0	0	0	0	0	0	0	0,000		
f4-f11	v66 Cell 7 voltage (mV) +ve -OK, -ve - channel mismatch	00	V/1000	(2,6,4,2)	1	0	0	0	0	0	0	0	0	0,000		
f4-f11	v67 Cell 0 voltage (mV) +ve -OK, -ve - channel mismatch	00	V/1000	(2,6,4,2)	1	0	0	0	0	0	0	0	0	0,000		
f4-f11	v68 Cell 1 voltage (mV) +ve -OK, -ve - channel mismatch	00	V/1000	(2,6,4,2)	1	0	0	0	0	0	0	0	0	0,000		
f4-f11	v69 Cell 2 voltage (mV) +ve -OK, -ve - channel mismatch	00	V/1000	(2,6,4,2)	1	0	0	0	0	0	0	0	0	0,000		
f4-f11	v70 Cell 3 voltage (mV) +ve -OK, -ve - channel mismatch	00	V/1000	(2,6,4,2)	1	0	0	0	0	0	0	0	0	0,000		
f4-f11	v71 Cell 4 voltage (mV) +ve -OK, -ve - channel mismatch	00	V/1000	(2,6,4,2)	1	0	0	0	0	0	0	0	0	0,000		
f4-f11	v72 Cell 5 voltage (mV) +ve -OK, -ve - channel mismatch	00	V/1000	(2,6,4,2)	1	0	0	0	0	0	0	0	0	0,000		
f4-f11	v73 Cell 6 voltage (mV) +ve -OK, -ve - channel mismatch	00	V/1000	(2,6,4,2)	1	0	0	0	0	0	0	0	0	0,000		
f4-f11	v74 Cell 7 voltage (mV) +ve -OK, -ve - channel mismatch	00	V/1000	(2,6,4,2)	1	0	0	0	0	0	0	0	0	0,000		
f4-f11	v75 Shows the balancing SOC as a percentage, in other words, the percentage mismatch between cells this session.	10	Ah(%)	(0,100)	0	0	0	0	0	0	0	0	0	0,000		
f4-f11	v76 Discharging cell voltage error (mV)	00	V/1000	(0,0,1)	10	0	0	0	0	0	0	0	0	0,000		
f4-f11	v77 Minimum / Maximum cell temperature	10	V/1000	(0,60)	0	0	0	0	0	0	0	0	0	0,000		
f4-f11	v78 CMU number that has the minimum cell temperature	10	0	NA	1	0	0	0	0	0	0	0	0	0,000		
f4-f11	v79 CMU number that has the maximum cell temperature	10	0	NA	1	0	0	0	0	0	0	0	0	0,000		
f11-f6	v80 Bus Current - Desired set point of current drawn from the bus by the controller as a percentage of absolute bus current limit.	01	A	(0,1)	1	0	0	0	0	0	0	0	0	0,000		
f11-f6	v81 DC Bus Amp/Hours - Charge flow into the controller DC bus from the time of reset.	01	Ah	NA	1	0	0	0	0	0	0	0	0	0,000		
f2-f11	v82 Temperature (°C)	00	°C	(30,70)	0	0	0	0	0	0	0	0	0	0,000		

Figure C.1: FDM Matrix for OS<sub>1</sub> of Primavera2 Vehicle - World Solar Challenge 2015

11-16	v83	Extended battery pack status	10	0	NA	0	0	0	3	0	1	0	3	0.000
11-16	v84	Motor Current -Desired motor current set point as a percentage of maximum current setting.	01	A	(0,30)	4	0	0	0	0	0	0	0	0.000
11-16	v85	Receive error count	10	0	NA	5	0	0	0	0	0	0	0	0.000
11-16	v86	Transmit error count	10	0	NA	5	0	0	0	0	0	0	0	0.000
11-16	v87	Minimum / Maximum cell voltage	00	0	(2,6;4,2)	1	0	0	0	3	0	0	0	0.000
12-11	v88	Temp(Temperature of MPPT +-5°C)	00	°C	(30,70)	0	0	0	0	3	0	0	0	0.000
11-16	v89	PCB temperature ( 1/10th °C)	00	°C	(0,80)	1	0	0	1	0	0	0	0	0.000
11-16	v90	Cell temperature ( 1/10th °C)	00	°C	(0,60)	1	0	0	1	0	0	0	0	0.000
11-16	v91	PCB temperature ( 1/10th °C)	00	°C	(0,80)	1	0	0	1	0	0	0	0	0.000
11-16	v92	Cell temperature ( 1/10th °C)	00	°C	(0,60)	1	0	0	1	0	0	0	0	0.000
11-16	v93	PCB temperature ( 1/10th °C)	00	°C	(0,80)	1	0	0	1	0	0	0	0	0.000
11-16	v94	Cell temperature ( 1/10th °C)	00	°C	(0,60)	1	0	0	1	0	0	0	0	0.000
11-16	v95	PCB temperature ( 1/10th °C)	00	°C	(0,80)	1	0	0	1	0	0	0	0	0.000
11-16	v96	Cell temperature ( 1/10th °C)	00	°C	(0,60)	1	0	0	1	0	0	0	0	0.000
11-16	v97	PCB temperature ( 1/10th °C)	00	°C	(0,80)	1	0	0	1	0	0	0	0	0.000
11-16	v98	Cell temperature ( 1/10th °C)	00	°C	(0,60)	1	0	0	1	0	0	0	0	0.000
11-16	v99	Cell temperature margin ( 1/10th °C)	00	°C	(0,1)	10	0	0	1	0	0	0	0	0.000
11-16	v100	CMU number that has the minimum cell voltage	10	0	NA	10	0	0	1	0	0	0	0	0.000
11-16	v101	CMU number that has the maximum cell voltage	10	0	NA	10	0	0	1	0	0	0	0	0.000
11-16	v102	12V current consumption of fans + contactors (mA)	00	V	(0,2000)	1	0	0	1	0	0	0	0	0.000
11-16	v103	12V current consumption of CMUs (mA)	00	A/1000	(0,2000)	1	0	0	1	0	0	0	0	0.000
11-16	v104	Precharge status, 12V status	10	0	NA	1	0	0	0	1	0	0	0	0.000
11-16	v105	12V contactor supply voltage, mV (only on v4 or earlier BMU) for v5 or later BMU, refer to binary bit 0x10 in data_w8[0]	00	V	(0,15)	1	0	0	0	1	0	0	0	0.000
11-16	v106	IPM Heat-sink Temp - Internal temperature of Heat-sink in main IPM	00	°C	(0,100)	1	0	0	0	1	0	0	0	0.000
11-16	v107	Motor Temp - Internal temperature of the motor.	00	°C	(0,60)	1	0	0	0	1	0	0	0	0.000
11-16	v108	Slip Speed -Slip speed when driving an induction motor	00	Hz	(0,100)	5	0	0	0	1	0	0	0	0.000
11-16	v109	BMU heartbeat & serial number	10	0	NA	1	0	0	0	0	0	0	0	0.000
11-16	v110	Device serial number as programmed at the factory	10	0	NA	1	0	0	0	0	0	0	0	0.000
11-16	v111	v5 and later: Device ID: 0x00001000	10	0	NA	1	0	0	0	0	0	0	0	0.000
11-16	v112	CMU status, temperature and voltage telemetry, if set to relay to vehicle	10	0	NA	1	0	0	0	0	0	0	0	0.000
11-16	v113	CMU # 1 status	20	0	NA	1	0	0	0	0	0	0	0	0.000
11-16	v114	CMU serial number (allocated at factory)	10	0	NA	1	0	0	0	0	0	0	0	0.000
11-16	v115	CMU # 2 status	20	0	NA	1	0	0	0	0	0	0	0	0.000
11-16	v116	CMU serial number (allocated at factory)	10	0	NA	1	0	0	0	0	0	0	0	0.000
11-16	v117	CMU # 3 status	20	0	NA	1	0	0	0	0	0	0	0	0.000
11-16	v118	CMU serial number (allocated at factory)	10	0	NA	1	0	0	0	0	0	0	0	0.000
11-16	v119	CMU # 4 status	20	0	NA	1	0	0	0	0	0	0	0	0.000
11-16	v120	CMU serial number (allocated at factory)	10	0	NA	1	0	0	0	0	0	0	0	0.000
11-16	v121	CMU # 5 status	20	0	NA	1	0	0	0	0	0	0	0	0.000
11-16	v122	CMU serial number (allocated at factory)	10	0	NA	1	0	0	0	0	0	0	0	0.000
11-16	v123	Reserved for factory configuration & calibration commands	11	0	NA	1	0	0	0	0	0	0	0	0.000
11-16	v124	Reserved for future configuration system update	11	0	NA	1	0	0	0	0	0	0	0	0.000
11-16	v125	Charger Control information	10	0	NA	1	0	0	0	0	0	0	0	0.000
11-16	v126	Charging cell voltage error (mV)	00	V/1000	(0,100)	10	0	0	0	0	0	0	0	0.000
11-16	v127	Precharge contactor driver status	20	0	NA	1	0	0	0	0	0	0	0	0.000
11-16	v128	Precharge state (in order of normal appearance when starting)	20	0	NA	1	0	0	0	0	0	0	0	0.000
11-16	v129	Unused, reports as 0x0000	10	0	NA	1	0	0	0	0	0	0	0	0.000
11-16	v130	0x1 - Precharge timer elapsed (Don't care if timeout disabled) 0x0 - Precharge timer not elapsed	00	s	NA	1	0	0	0	0	0	0	0	0.000
11-16	v131	Precharge timer counter (10ms per count)	00	s/1000	NA	1	0	0	0	0	0	0	0	0.000
11-16	v132	Unused, reads as 0x00	10	0	NA	1	0	0	0	0	0	0	0	0.000
11-16	v133	Unused, reads as 0x00	10	0	NA	1	0	0	0	0	0	0	0	0.000
11-16	v134	Balance voltage threshold - rising (balance resistor turns on)	11	V/1000	(40,00)	1	0	0	0	0	0	0	0	0.000
11-16	v135	Balance voltage threshold - falling (balance resistor turns off)	11	V/1000	(40,50)	1	0	0	0	0	0	0	0	0.000
11-16	v136	BMS CMU count	10	0	NA	1	0	0	0	0	0	0	0	0.000
11-16	v137	BMS BMU Firmware Build Number	10	0	NA	1	0	0	0	0	0	0	0	0.000
11-16	v138	Fan & 12V supply status	20	0	NA	1	0	0	0	0	0	0	0	0.000
11-16	v139	Fan speed 0 (rpm)	00	rpm	(0,2000)	1	0	0	0	0	0	0	0	0.000
11-16	v140	Fan speed 1 (rpm)	00	rpm	(0,2000)	1	0	0	0	0	0	0	0	0.000
11-16	v141	BMU Hardware version	10	0	NA	1	0	0	0	0	0	0	0	0.000
11-16	v142	BMU Model ID	10	0	NA	1	0	0	0	0	0	0	0	0.000
11-16	v143	Unused	10	0	NA	1	0	0	0	0	0	0	0	0.000
11-16	v144	Unused	10	0	NA	1	0	0	0	0	0	0	0	0.000
11-16	v145	Unused	10	0	NA	1	0	0	0	0	0	0	0	0.000
11-16	v146	Serial Number -Device serial number, allocated at manufacture	10	0	NA	1	0	0	0	0	0	0	0	0.000
11-16	v147	Tritium ID - "T088" stored as a string, msg[0] - 'T', msg[1] - '0'...	10	0	NA	1	0	0	0	0	0	0	0	0.000
11-16	v148	Active Motor	10	0	(0,10)	5	0	0	0	0	0	0	0	0.000
11-16	v149	Motor Velocity -Motor angular frequency in revolutions per minute	00	rpm	(0,2000)	5	0	0	0	0	0	0	0	0.000
11-16	v150	Phase C Current Arms RMS current in motor Phase C	00	Arms	(0,60)	5	0	0	0	0	0	0	0	0.000
11-16	v151	Phase B Current -RMS current in motor Phase B	00	Arms	(0,60)	5	0	0	0	0	0	0	0	0.000
11-16	v152	Real component of the applied non-rotating voltage vector to the motor.	00	V	(0,147)	5	0	0	0	0	0	0	0	0.000
11-16	v153	Imaginary component of the applied non-rotating voltage vector to the motor.	00	V	(0,147)	5	0	0	0	0	0	0	0	0.000
11-16	v154	Real component of the applied non-rotating current vector to the motor. This vector represents the field current of the motor.	00	A	(0,60)	5	0	0	0	0	0	0	0	0.000
11-16	v155	Imaginary component of the applied non-rotating current vector to the motor. This current produces torque in the motor and should be in phase with the back-EMF of the motor.	00	A	(0,60)	5	0	0	0	0	0	0	0	0.000
11-16	v156	BEMF4 -By definition this value is always 0V	00	V	(0)	5	0	0	0	0	0	0	0	0.000
11-16	v157	BEMFq - The peak of the phase to neutral motor voltage.	00	V	(0)	5	0	0	0	0	0	0	0	0.000
11-16	v158	15V supply - Actual voltage level of the 15V power rail.	00	V	(12,15)	1	0	0	0	0	0	0	0	0.000
11-16	v159	Reserved	10	0	NA	1	0	0	0	0	0	0	0	0.000
11-16	v160	3.3V supply - Actual voltage level of the 3.3V power rail.	00	V	(3,13,3)	1	0	0	0	0	0	0	0	0.000
11-16	v161	1.9V supply - Actual voltage level of the 1.9V DSP power rail.	00	V	(1,8,1,9)	1	0	0	0	0	0	0	0	0.000
11-16	v162	Reserved	10	0	NA	1	0	0	0	0	0	0	0	0.000
11-16	v163	Reserved	10	0	NA	1	0	0	0	0	0	0	0	0.000
11-16	v164	Reserved	10	0	NA	1	0	0	0	0	0	0	0	0.000
11-16	v165	DSP Board Temp - Temperature of the DSP board.	00	°C	(0,60)	1	0	0	0	0	0	0	0	0.000
11-16	v166	Reserved	10	0	NA	1	0	0	0	0	0	0	0	0.000
11-16	v167	Reserved	10	0	NA	1	0	0	0	0	0	0	0	0.000
11-16	v168	Reserved	10	0	NA	5	0	0	0	0	0	0	0	0.000
12-11	v169	NOC-No Charge Plug (0- Battery Connected, 1-Battery Disconnected)	20	0	NA	0	0	0	0	0	0	0	0	0.000

Figure C.2: FDM Matrix (continuation) for OS<sub>1</sub> of Primavera2 Vehicle - World Solar Challenge 2015

FLOWS	VARIABLE	ATTRIBUTES				BASIC FUNCTIONS										Variable Relevance
		alpha	Beta	Gamma	Delta (Hz)	To maintain	To provide	To store	To recover	To collect	to perform	to send	to calculate	OS'a		
						Structural Integrity FU4	Life Support FU5	Energy FU7	kinetic energy FU9	energy from the sun FU10	driving actions FU12	vehicle data to crew FU13	speed setpoint FU14			
						0,25	0,25	0,16666667	0,08333333	0,08333333	0,08333333	0,04166667	0,04166667	wfu		
f4-f11	v1 Battery Voltage (mV)	00	V/1000	(90,147)	10	0	0	9	9	9	3	0	9	0,319		
f4-f11	v2 Battery Current (mA)	01	A/1000	(0,30)	10	0	0	9	9	9	3	0	9	0,319		
f4-f11	v4 Pack SOC	00				0	0	9	9	3	3	0	9	0,319		
f4-f11	v5 SOC (Ah). Shows Ah consumed from the pack. 0 = Full, and counts upwards towards the user-set pack capacity number as Ah are used. Resets to 0 when max cell reaches balance threshold.	00	Ah	(0,40.8)	1	0	0	9	9	3	3	0	9	0,319		
f4-f11	v6 Shows the SOC as a percentage. 100% = full, 0% = empty	10		(0,100)	1	0	0	9	9	3	3	0	9	0,319		
f2-f11'	v7 Battery Voltage (mV)	00	V/1000	(90,147)	0	0	0	9	9	3	3	0	9	0,319		
f2-f11'	v8 Battery Current	01	A	(0,30)	0	0	0	9	9	3	3	0	9	0,319		
f4-f11	v9 Maximum cell voltage (mV)	00	V/1000	(2,54.2)	10	0	0	9	9	3	3	0	9	0,282		
f1-f16	v10 Bus Voltage - DC bus voltage at the controller.	00	V/1000	(90,147)	5	0	0	9	9	3	0	0	3	0,264		
f2-f11'	v11 Capacity (mAh)	00	Ah/1000	(0,40.8)	0	0	0	9	1	3	3	0	9	0,245		
f4-f11	v12 Minimum cell voltage (mV)	00	V/1000	(2,54.2)	10	0	0	9	3	3	3	0	3	0,236		
f4-f11	v13 Status Flags	10	0	NA	1	0	0	9	3	3	3	0	3	0,236		
f2-f11	v14 Uout(output Voltage)	00	V	(90,147)	0	0	0	9	0	9	0	0	0	0,167		
f4-f11	v15 Total pack capacity (Ah)	00	Ah	(0,40.8)	10	0	0	9	3	0	0	0	9	0,236		
f4-f11	v16 Status Flags	10	0	NA	1	0	0	9	3	0	3	0	3	0,236		
f2-f11	v17 B1LR - Battery Voltage Level Reached Flag (0= Uout<UoutMax, 1=Uout=UoutMax)	20	V	NA	0	0	0	3	9	9	0	0	0	0,139		
f2-f11	v18 B1LR - Battery Voltage Level Reached Flag (0= Uout<UoutMax, 1=Uout=UoutMax)	20	V	NA	0	0	0	3	9	9	0	0	0	0,139		
f4-f11	v19 Battery pack status	00	m	NA	1	0	0	9	0	3	1	0	3	0,190		
f1-f16	v20 Odometer - Distance the vehicle has travelled since reset.	00	m	NA	1	0	0	0	0	9	9	0	9	0,125		
f4-f11	v21 Bus Current - Current drawn from the DC bus by the controller.	00	A	(0,30)	5	0	0	9	0	0	0	0	9	0,181		
f4-f11	v22 Maximum cell temperature (1/10th °C)	00	°C/10	(20,55)	1	0	0	9	0	0	0	0	1	0,171		
f4-f11	v23 Cell number in CMU that is the minimum cell voltage	10	V/1000	NA	10	0	0	9	0	0	0	0	0	0,167		
f4-f11	v24 Cell number in CMU that is the maximum cell voltage	10	V/1000	NA	10	0	0	9	0	0	0	0	0	0,167		
f1-f16	v25 Error Flags	20	0	NA	5	0	0	0	9	0	9	0	0	0,167		
f1-f16	v26 Limit Flags	10	0	NA	5	0	0	0	9	0	9	0	0	0,167		
f1-f16	v27 Vehicle Velocity - Vehicle velocity in metres / second	01	m/s	(16,6, 33,3)	5	0	0	0	3	0	9	0	9	0,153		
f2-f11	v28 Iin(Input Current)	00	A	(0,4)	0	0	0	0	3	9	0	0	9	0,069		
f2-f11	v29 Uin (Input Voltage)	00	V	(36-141.4)	0	0	0	0	0	9	0	0	9	0,042		
f2-f11	v30 OTT- Overtemperature Flag (0= Temp<95°C, 1=Temp>=95°C)	20	°C	NA	0	0	0	0	0	9	0	0	0	0,000		
f1-f16	v31 Motor Velocity (rpm) Desired motor velocity set point in rpm	01	(pi/30)Ra d/s	(850,1100)	4	0	0	0	1	0	3	0	9	0,079		
f4-f11	v32 Balance SOC	00				0	0	3	0	0	0	0	3	0,069		
f4-f11	v33 Balance SOC (Ah). Shows Ah supplied to the pack since the first cell began balancing. This number will continue to count up until all cells in the pack are balancing, therefore showing the Ah mismatch that has been corrected during this balancing session.	00	Ah	(0,40.8)	1	0	0	0	3	0	0	0	3	0,069		
f4-f11	v34 Minimum cell temperature (1/10th °C)	20	0	NA	1	0	0	0	3	0	0	0	1	0,060		
f4-f11	v35 Cell 0 voltage (mV). +ve - OK, -ve - channel mismatch	00	V/1000	(2,64.2)	1	0	0	0	3	0	0	0	0	0,056		
f4-f11	v36 Cell 1 voltage (mV). +ve - OK, -ve - channel mismatch	00	V/1000	(2,64.2)	1	0	0	0	3	0	0	0	0	0,056		
f4-f11	v37 Cell 2 voltage (mV). +ve - OK, -ve - channel mismatch	00	V/1000	(2,64.2)	1	0	0	0	3	0	0	0	0	0,056		
f4-f11	v38 Cell 3 voltage (mV). +ve - OK, -ve - channel mismatch	00	V/1000	(2,64.2)	1	0	0	0	3	0	0	0	0	0,056		
f4-f11	v39 Cell 4 voltage (mV). +ve - OK, -ve - channel mismatch	00	V/1000	(2,64.2)	1	0	0	0	3	0	0	0	0	0,056		
f4-f11	v40 Cell 5 voltage (mV). +ve - OK, -ve - channel mismatch	00	V/1000	(2,64.2)	1	0	0	0	3	0	0	0	0	0,056		
f4-f11	v41 Cell 6 voltage (mV). +ve - OK, -ve - channel mismatch	00	V/1000	(2,64.2)	1	0	0	0	3	0	0	0	0	0,056		
f4-f11	v42 Cell 7 voltage (mV). +ve - OK, -ve - channel mismatch	00	V/1000	(2,64.2)	1	0	0	0	3	0	0	0	0	0,056		
f4-f11	v43 Cell 0 voltage (mV). +ve - OK, -ve - channel mismatch	00	V/1000	(2,64.2)	1	0	0	0	3	0	0	0	0	0,056		
f4-f11	v44 Cell 1 voltage (mV). +ve - OK, -ve - channel mismatch	00	V/1000	(2,64.2)	1	0	0	0	3	0	0	0	0	0,056		
f4-f11	v45 Cell 2 voltage (mV). +ve - OK, -ve - channel mismatch	00	V/1000	(2,64.2)	1	0	0	0	3	0	0	0	0	0,056		
f4-f11	v46 Cell 3 voltage (mV). +ve - OK, -ve - channel mismatch	00	V/1000	(2,64.2)	1	0	0	0	3	0	0	0	0	0,056		
f4-f11	v47 Cell 4 voltage (mV). +ve - OK, -ve - channel mismatch	00	V/1000	(2,64.2)	1	0	0	0	3	0	0	0	0	0,056		
f4-f11	v48 Cell 5 voltage (mV). +ve - OK, -ve - channel mismatch	00	V/1000	(2,64.2)	1	0	0	0	3	0	0	0	0	0,056		
f4-f11	v49 Cell 6 voltage (mV). +ve - OK, -ve - channel mismatch	00	V/1000	(2,64.2)	1	0	0	0	3	0	0	0	0	0,056		
f4-f11	v50 Cell 7 voltage (mV). +ve - OK, -ve - channel mismatch	00	V/1000	(2,64.2)	1	0	0	0	3	0	0	0	0	0,056		
f4-f11	v51 Cell 0 voltage (mV). +ve - OK, -ve - channel mismatch	00	V/1000	(2,64.2)	1	0	0	0	3	0	0	0	0	0,056		
f4-f11	v52 Cell 1 voltage (mV). +ve - OK, -ve - channel mismatch	00	V/1000	(2,64.2)	1	0	0	0	3	0	0	0	0	0,056		
f4-f11	v53 Cell 2 voltage (mV). +ve - OK, -ve - channel mismatch	00	V/1000	(2,64.2)	1	0	0	0	3	0	0	0	0	0,056		
f4-f11	v54 Cell 3 voltage (mV). +ve - OK, -ve - channel mismatch	00	V/1000	(2,64.2)	1	0	0	0	3	0	0	0	0	0,056		
f4-f11	v55 Cell 4 voltage (mV). +ve - OK, -ve - channel mismatch	00	V/1000	(2,64.2)	1	0	0	0	3	0	0	0	0	0,056		
f4-f11	v56 Cell 5 voltage (mV). +ve - OK, -ve - channel mismatch	00	V/1000	(2,64.2)	1	0	0	0	3	0	0	0	0	0,056		
f4-f11	v57 Cell 6 voltage (mV). +ve - OK, -ve - channel mismatch	00	V/1000	(2,64.2)	1	0	0	0	3	0	0	0	0	0,056		
f4-f11	v58 Cell 7 voltage (mV). +ve - OK, -ve - channel mismatch	00	V/1000	(2,64.2)	1	0	0	0	3	0	0	0	0	0,056		
f4-f11	v59 Cell 0 voltage (mV). +ve - OK, -ve - channel mismatch	00	V/1000	(2,64.2)	1	0	0	0	3	0	0	0	0	0,056		
f4-f11	v60 Cell 1 voltage (mV). +ve - OK, -ve - channel mismatch	00	V/1000	(2,64.2)	1	0	0	0	3	0	0	0	0	0,056		
f4-f11	v61 Cell 2 voltage (mV). +ve - OK, -ve - channel mismatch	00	V/1000	(2,64.2)	1	0	0	0	3	0	0	0	0	0,056		
f4-f11	v62 Cell 3 voltage (mV). +ve - OK, -ve - channel mismatch	00	V/1000	(2,64.2)	1	0	0	0	3	0	0	0	0	0,056		
f4-f11	v63 Cell 4 voltage (mV). +ve - OK, -ve - channel mismatch	00	V/1000	(2,64.2)	1	0	0	0	3	0	0	0	0	0,056		
f4-f11	v64 Cell 5 voltage (mV). +ve - OK, -ve - channel mismatch	00	V/1000	(2,64.2)	1	0	0	0	3	0	0	0	0	0,056		
f4-f11	v65 Cell 6 voltage (mV). +ve - OK, -ve - channel mismatch	00	V/1000	(2,64.2)	1	0	0	0	3	0	0	0	0	0,056		
f4-f11	v66 Cell 7 voltage (mV). +ve - OK, -ve - channel mismatch	00	V/1000	(2,64.2)	1	0	0	0	3	0	0	0	0	0,056		
f4-f11	v67 Cell 0 voltage (mV). +ve - OK, -ve - channel mismatch	00	V/1000	(2,64.2)	1	0	0	0	3	0	0	0	0	0,056		
f4-f11	v68 Cell 1 voltage (mV). +ve - OK, -ve - channel mismatch	00	V/1000	(2,64.2)	1	0	0	0	3	0	0	0	0	0,056		
f4-f11	v69 Cell 2 voltage (mV). +ve - OK, -ve - channel mismatch	00	V/1000	(2,64.2)	1	0	0	0	3	0	0	0	0	0,056		
f4-f11	v70 Cell 3 voltage (mV). +ve - OK, -ve - channel mismatch	00	V/1000	(2,64.2)	1	0	0	0	3	0	0	0	0	0,056		
f4-f11	v71 Cell 4 voltage (mV). +ve - OK, -ve - channel mismatch	00	V/1000	(2,64.2)	1	0	0	0	3	0	0	0	0	0,056		
f4-f11	v72 Cell 5 voltage (mV). +ve - OK, -ve - channel mismatch	00	V/1000	(2,64.2)	1	0	0	0	3	0	0	0	0	0,056		
f4-f11	v73 Cell 6 voltage (mV). +ve - OK, -ve - channel mismatch	00	V/1000	(2,64.2)	1	0	0	0	3	0	0	0	0	0,056		
f4-f11	v74 Cell 7 voltage (mV). +ve - OK, -ve - channel mismatch	00	V/1000	(2,64.2)	1	0	0	0	3	0	0	0	0	0,056		
f4-f11	v75 Shows the balancing SOC as a percentage, in other words, the percentage mismatch between cells this session.	10	Ah(%)	(0,100)	0	0	0	0	3	0	0	0	0	0,056		
f4-f11	v76 Discharging cell voltage error (mV)	00	V/1000	(0,1)	10	0	0	0	3	0	0	0	0	0,056		
f4-f11	v77 Minimum (Maximum) cell temperature	10	V/1000	(0,60)	0	0	0	0	3	0	0	0	0	0,056		
f4-f11	v78 CMU number that has the minimum cell temperature	10	0	NA	1	0	0	0	3	0	0	0	0	0,056		
f4-f11	v79 CMU number that has the maximum cell temperature	10	0	NA	1	0	0	0	3	0	0	0	0	0,056		
f1-f16	v80 Bus Current - Desired set point of current drawn from the bus by the controller as a percentage of absolute bus current limit.	01	A	(0,1)	1	0	0	0	3	0	0	0	0	0,056		
f1-f16	v81 DC Bus Amplitudes - Charge flow into the controller DC bus from the time of reset.	01	Ah	NA	1	0	0	0	3	0	0	0	0	0,056		
f2-f11'	v82 Temperature (°C)	00	°C	(30,70)	0	0	0	0	3	0	0	0	9	0,056		

Figure C.3: FDM Matrix for OS<sub>2</sub> of Primavera2 Vehicle - World Solar Challenge 2015

11-16	v83	Extended battery pack status	10	0	NA	0	0	0	0	3	0	1	0	3	0.051
11-16	v84	Motor Current - Desired motor current set point as a percentage of maximum current setting.	01	A	(0,30)	4	0	0	0	0	0	0	0	9	0.042
11-16	v85	Receive error count.	10	0	NA	5	0	0	0	0	0	0	0	9	0.042
11-16	v86	Transmit error count	10	0	NA	5	0	0	0	0	0	0	0	9	0.042
11-16	v87	Minimum / Maximum cell voltage	00	0	(2,6,4,2)	1	0	0	0	3	0	0	0	0	0.028
11-16	v88	Temp (temperature of MPPPT +/- 5°C)	00	°C	(30,70)	0	0	0	0	0	3	0	0	0	0.000
11-16	v89	PCB temperature (1/10th °C)	00	°C	(0,80)	1	0	0	1	0	0	0	0	0	0.019
11-16	v90	Cell temperature (1/10th °C)	00	°C	(0,60)	1	0	0	1	0	0	0	0	0	0.019
11-16	v91	PCB temperature (1/10th °C)	00	°C	(0,80)	1	0	0	1	0	0	0	0	0	0.019
11-16	v92	Cell temperature (1/10th °C)	00	°C	(0,60)	1	0	0	1	0	0	0	0	0	0.019
11-16	v93	PCB temperature (1/10th °C)	00	°C	(0,80)	1	0	0	1	0	0	0	0	0	0.019
11-16	v94	Cell temperature (1/10th °C)	00	°C	(0,60)	1	0	0	1	0	0	0	0	0	0.019
11-16	v95	PCB temperature (1/10th °C)	00	°C	(0,80)	1	0	0	1	0	0	0	0	0	0.019
11-16	v96	Cell temperature (1/10th °C)	00	°C	(0,60)	1	0	0	1	0	0	0	0	0	0.019
11-16	v97	PCB temperature (1/10th °C)	00	°C	(0,80)	1	0	0	1	0	0	0	0	0	0.019
11-16	v98	Cell temperature (1/10th °C)	00	°C	(0,60)	1	0	0	1	0	0	0	0	0	0.019
11-16	v99	Cell temperature margin (1/10th °C)	00	°C	(0,1)	10	0	0	1	0	0	0	0	0	0.019
11-16	v100	CMU number that has the minimum cell voltage	10	0	NA	10	0	0	0	1	0	0	0	0	0.019
11-16	v101	CMU number that has the maximum cell voltage	10	0	NA	10	0	0	0	1	0	0	0	0	0.019
11-16	v102	12V current consumption of fans + contactors (mA)	00	V	(0,2000)	1	0	0	0	1	0	0	0	0	0.019
11-16	v103	12V current consumption of CMUs (mA)	00	A/1000	(0,2000)	1	0	0	0	1	0	0	0	0	0.019
11-16	v104	Precharge status, 12V status	10	0	NA	1	0	0	0	0	1	0	0	0	0.009
11-16	v105	12V contactor supply voltage, mV (only on v4 or earlier BMU) for v5 or later BMU refer to binary bit (x10 in data sheet)	00	V	(0,15)	1	0	0	0	0	1	0	0	0	0.009
11-16	v106	1PM Heat-sink Temp - Internal temperature of Heat-sink in main 1PM	00	°C	(0,100)	1	0	0	0	1	0	0	0	0	0.009
11-16	v107	Motor Temp - Internal temperature of the motor.	00	°C	(0,60)	1	0	0	0	1	0	0	0	0	0.009
11-16	v108	Slip Speed - Slip speed when driving an induction motor	00	Hz	(0,100)	5	0	0	0	0	1	0	0	0	0.009
11-16	v109	BMU heartbeat & serial number	10	0	NA	1	0	0	0	0	0	0	0	0	0.000
11-16	v110	Device serial number as programmed at the factory	10	0	NA	1	0	0	0	0	0	0	0	0	0.000
11-16	v111	v5 and later: Device ID: 0x00001000	10	0	NA	1	0	0	0	0	0	0	0	0	0.000
11-16	v112	CMU status, temperature and voltage telemetry, if set to relay to vehicle	20	0	NA	1	0	0	0	0	0	0	0	0	0.000
11-16	v113	CMU # 1 status	20	0	NA	1	0	0	0	0	0	0	0	0	0.000
11-16	v114	CMU serial number (allocated at factory)	10	0	NA	1	0	0	0	0	0	0	0	0	0.000
11-16	v115	CMU # 2 status	20	0	NA	1	0	0	0	0	0	0	0	0	0.000
11-16	v116	CMU serial number (allocated at factory)	10	0	NA	1	0	0	0	0	0	0	0	0	0.000
11-16	v117	CMU # 3 status	20	0	NA	1	0	0	0	0	0	0	0	0	0.000
11-16	v118	CMU serial number (allocated at factory)	10	0	NA	1	0	0	0	0	0	0	0	0	0.000
11-16	v119	CMU # 4 status	20	0	NA	1	0	0	0	0	0	0	0	0	0.000
11-16	v120	CMU serial number (allocated at factory)	10	0	NA	1	0	0	0	0	0	0	0	0	0.000
11-16	v121	CMU # 5 status	20	0	NA	1	0	0	0	0	0	0	0	0	0.000
11-16	v122	CMU serial number (allocated at factory)	10	0	NA	1	0	0	0	0	0	0	0	0	0.000
11-16	v123	Reserved for factory configuration & calibration commands	11	0	NA	1	0	0	0	0	0	0	0	0	0.000
11-16	v124	Reserved for future configuration system update	11	0	NA	1	0	0	0	0	0	0	0	0	0.000
11-16	v125	Charger Control information	10	0	NA	0	0	0	0	0	0	0	0	0	0.000
11-16	v126	Charging cell voltage error (mV)	00	V/1000	(0,100)	10	0	0	0	0	0	0	0	0	0.000
11-16	v127	Precharge contactor driver status	20	0	NA	1	0	0	0	0	0	0	0	0	0.000
11-16	v128	Precharge state (in order of normal appearance when starting)	20	0	NA	1	0	0	0	0	0	0	0	0	0.000
11-16	v129	Unused, reports as 0x0000	10	0	NA	1	0	0	0	0	0	0	0	0	0.000
11-16	v130	0x01 - Precharge timer elapsed (Don't care if timeout disabled) 0x00 - Precharge timer not elapsed	00	s	NA	1	0	0	0	0	0	0	0	0	0.000
11-16	v131	Precharge timer counter (10ms per count)	00	s/1000	NA	1	0	0	0	0	0	0	0	0	0.000
11-16	v132	Unused, reads as 0x00	10	0	NA	1	0	0	0	0	0	0	0	0	0.000
11-16	v133	Unused, reads as 0x00	10	0	NA	1	0	0	0	0	0	0	0	0	0.000
11-16	v134	Balance voltage threshold - rising (balance resistor turns on)	11	V/1000	(4,100)	1	0	0	0	0	0	0	0	0	0.000
11-16	v135	Balance voltage threshold - falling (balance resistor turns off)	11	V/1000	(6,050)	1	0	0	0	0	0	0	0	0	0.000
11-16	v136	BMS CMU count	10	0	NA	1	0	0	0	0	0	0	0	0	0.000
11-16	v137	BMS BMU Firmware Build Number	10	0	NA	1	0	0	0	0	0	0	0	0	0.000
11-16	v138	Fan & 12V supply status	20	0	NA	1	0	0	0	0	0	0	0	0	0.000
11-16	v139	Fan speed 0 (rpm)	00	rpm	(0,2000)	1	0	0	0	0	0	0	0	0	0.000
11-16	v140	Fan speed 1 (rpm)	00	rpm	(0,2000)	1	0	0	0	0	0	0	0	0	0.000
11-16	v141	BMU Hardware version	10	0	NA	1	0	0	0	0	0	0	0	0	0.000
11-16	v142	BMU Model ID	10	0	NA	1	0	0	0	0	0	0	0	0	0.000
11-16	v143	Unused	10	0	NA	1	0	0	0	0	0	0	0	0	0.000
11-16	v144	Unused	10	0	NA	1	0	0	0	0	0	0	0	0	0.000
11-16	v145	Unused	10	0	NA	1	0	0	0	0	0	0	0	0	0.000
11-16	v146	Serial Number - Device serial number, allocated at manufacture	10	0	NA	1	0	0	0	0	0	0	0	0	0.000
11-16	v147	Tritium ID - "T088" stored as a string, msg[0] = 'T', msg[1] = '0'...	10	0	NA	1	0	0	0	0	0	0	0	0	0.000
11-16	v148	Active Motor	10	0	(0,10)	5	0	0	0	0	0	0	0	0	0.000
11-16	v149	Motor Velocity - Motor angular frequency in revolutions per minute	00	rpm	(0,2000)	5	0	0	0	0	0	0	0	0	0.000
11-16	v150	Phase C Current Arms RMS current in motor Phase C	00	Arms	(0,60)	5	0	0	0	0	0	0	0	0	0.000
11-16	v151	Phase B Current - RMS current in motor Phase B	00	Arms	(0,60)	5	0	0	0	0	0	0	0	0	0.000
11-16	v152	Real component of the applied non-rotating voltage vector to the motor.	00	V	(0,147)	5	0	0	0	0	0	0	0	0	0.000
11-16	v153	Imaginary component of the applied non-rotating voltage vector to the motor.	00	V	(0,147)	5	0	0	0	0	0	0	0	0	0.000
11-16	v154	Real component of the applied non-rotating current vector to the motor. This vector represents the field current of the motor	00	A	(0,60)	5	0	0	0	0	0	0	0	0	0.000
11-16	v155	Imaginary component of the applied non-rotating current vector to the motor. This current produces torque in the motor and should be in phase with the back-EMF of 00 the motor.	00	A	(0,60)	5	0	0	0	0	0	0	0	0	0.000
11-16	v156	BEMFq - By definition this value is always 0V	00	V	(0)	5	0	0	0	0	0	0	0	0	0.000
11-16	v157	BEMFq - The peak of the phase to neutral motor voltage.	00	V	(0)	5	0	0	0	0	0	0	0	0	0.000
11-16	v158	15V supply - Actual voltage level of the 15V power rail.	00	V	(12,15)	1	0	0	0	0	0	0	0	0	0.000
11-16	v159	Reserved	10	0	NA	1	0	0	0	0	0	0	0	0	0.000
11-16	v160	3.3V supply - Actual voltage level of the 3.3V power rail	00	V	(3,1,3,3)	1	0	0	0	0	0	0	0	0	0.000
11-16	v161	1.9V supply - Actual voltage level of the 1.9V DSP power rail.	00	V	(1,8,1,9)	1	0	0	0	0	0	0	0	0	0.000
11-16	v162	Reserved	10	0	NA	1	0	0	0	0	0	0	0	0	0.000
11-16	v163	Reserved	10	0	NA	1	0	0	0	0	0	0	0	0	0.000
11-16	v164	Reserved	10	0	NA	1	0	0	0	0	0	0	0	0	0.000
11-16	v165	DSP Board Temp - Temperature of the DSP board.	00	°C	(0,60)	1	0	0	0	0	0	0	0	0	0.000
11-16	v166	Reserved	10	0	NA	1	0	0	0	0	0	0	0	0	0.000
11-16	v167	Reserved	10	0	NA	1	0	0	0	0	0	0	0	0	0.000
11-16	v168	Reserved	10	0	NA	5	0	0	0	0	0	0	0	0	0.000
11-16	v169	NOX - No Charge Flag (0 - Battery Connected, 1 - Battery Disconnected)	20	0	NA	0	0	0	0	0	0	0	0	0	0.000

Figure C.4: FDM Matrix (continuation) for OS<sub>2</sub> of Primavera2 Vehicle - World Solar Challenge 2015</

FLOWS	VARIABLE	ATTRIBUTES				BASIC FUNCTIONS										Variable Relevance
		alpha	Beta	Gamma	Delta (Hz)	To maintain Structural Integrity	To provide Life Support	To store Energy	To recover kinetic energy	To collect energy from the sun	to perform driving actions	to send vehicle data to crew	to calculate speed	OS'n wfa		
						FU4	FU5	FU7	FU9	FU10	FU12	FU13	FU14			
						0,25	0,25	0,1666667	0,0833333	0,0833333	0,0833333	0,0416667	0,0416667			
f4-f11	v1 Battery pack voltage & current					0	0	9	9	9	3	0	9	0,46		
f4-f11	v2 Battery Voltage (mV)	00	V/1000	(90,147)	10	0	0	9	9	9	3	0	9	0,463		
f4-f11	v3 Battery Current (mA)	01	A/1000	(0,30)	10	0	0	9	9	9	3	0	9	0,463		
f4-f11	v4 Pack SOC					0	0	9	9	9	3	0	9	0,347		
	SOC (Ah). Shows Ah consumed from the pack. 0 = Full, and counts upwards towards the user-set pack capacity number as Ah are used. Resets to 0 when max cell reaches balance threshold.															
f4-f11	v5	00	Ah	(0,40,8)	1	0	0	9	9	3	3	0	9	0,347		
f4-f11	v6 Shows the SOC as a percentage. 100%= full, 0% = empty	10		(0,100)	1	0	0	9	9	3	3	0	9	0,347		
f2'-f11'	v7 Battery Voltage (mV)	00	V/1000	(90,147)	0	0	0	9	9	3	3	0	9	0,347		
f2'-f11'	v8 Battery Current	01	A	(0,30)	0	0	0	9	9	3	3	0	9	0,347		
f4-f11	v9 Maximum cell voltage (mV)	00	v/1000	(2,6,4,2)	10	0	0	9	9	3	3	0	3	0,319		
f11-f6	v10 Bus Voltage - DC bus voltage at the controller.	00	V/1000	(90,147)	5	0	0	9	9	3	0	0	3	0,292		
f2'-f11'	v11 Capacity (mAh)	00	Ah/1000	(0,40,8)	0	0	0	9	1	3	3	0	9	0,273		
f4-f11	v12 Minimum cell voltage (mV)	00	V/1000	(2,5,4,2)	10	0	0	9	3	3	3	0	9	0,264		
f4-f11	v13 Status Flags	10	0	NA	1	0	0	9	3	3	3	0	3	0,264		
f4-f11	v14 Uout(output Voltage)	00	V	(90,147)	0	0	0	9	0	9	0	0	0	0,250		
f4-f11	v15 Total pack capacity (Ah)	00	Ah	(0,40,8)	10	0	0	9	3	0	0	0	9	0,236		
f4-f11	v16 Status Flags	10	0	NA	1	0	0	9	3	0	3	0	3	0,236		
f2-f11	v17 Uout<LoutMax, I=Uout=UoutMax	0=	V	NA	0	0	0	3	9	9	0	0	0	0,222		
f2-f11	v18 BVLr- Battery Voltage Level Reached Flag (0= Uout<LoutMax, I=Uout=UoutMax)	0=	V	NA	0	0	0	3	9	9	0	0	0	0,222		
f4-f11	v19 Battery pack status	00				0	0	9	0	3	1	0	3	0,218		
f11-f6	v20 Odometer - Distance the vehicle has travelled since reset.	00	m	NA	1	0	0	0	0	9	9	0	9	0,208		
f11-f6	v21 Bus Current - Current drawn from the DC bus by the controller.	00	A	(0,30)	5	0	0	9	0	0	0	0	3	0,181		
f4-f11	v22 Maximum cell temperature (1/10th °C)	00	°C/10	(20,55)	1	0	0	9	0	0	0	0	1	0,171		
f4-f11	v23 Cell number in CMU that is the minimum cell voltage	10	V/1000	NA	10	0	0	9	0	0	0	0	0	0,167		
f4-f11	v24 Cell number in CMU that is the maximum cell voltage	10	V/1000	NA	10	0	0	9	0	0	0	0	0	0,167		
f11-f6	v25 Error Flags	20	0	NA	5	0	0	9	0	0	9	0	0	0,167		
f11-f6	v26 Limit Flags	10	0	NA	5	0	0	9	0	0	0	0	0	0,167		
f11-f6	v27 Vehicle Velocity- Vehicle velocity in metres / second	01	m/s	(16,6,33,3)	5	0	0	0	3	0	9	0	9	0,153		
f2-f11	v28 Iin(Input Current)	00	A	(0,4)	0	0	0	0	3	9	0	0	9	0,153		
f2-f11	v29 Vin (Input Voltage)	00	V	(36-141,4)	0	0	0	0	0	9	0	0	9	0,125		
f2-f11	v30 OVT- Overtemperature Flag (0= Temp<95°C, 1=Temp>=95°C)	20	°C	NA	0	0	0	0	0	9	0	0	0	0,083		
f11-f6	v31 Motor Velocity (rpm) Desired motor velocity set point in rpm	01	(pi/30)Ra ds	(850,1100)	4	0	0	0	1	0	3	0	9	0,079		
f4-f11	v32 Balance SOC					0	0	0	3	0	0	0	3	0,069		
	Balance SOC (Ah). Shows Ah supplied to the pack since the first cell began balancing. This number will continue to count up until all cells in the pack are balancing, therefore showing the Ah mismatch that has been corrected during this balancing session.															
f4-f11	v33	00	Ah	(0,40,8)	1	0	0	3	0	0	0	0	3	0,069		
f4-f11	v34 Minimum cell temperature (1/10th °C)	20	0	NA	1	0	0	3	0	0	0	0	1	0,060		
f4-f11	v35 Cell 0 voltage (mV). +ve = OK, -ve = channel mismatch	00	V/1000	(2,6,4,2)	1	0	0	3	0	0	0	0	0	0,056		
f4-f11	v36 Cell 1 voltage (mV). +ve = OK, -ve = channel mismatch	00	V/1000	(2,6,4,2)	1	0	0	3	0	0	0	0	0	0,056		
f4-f11	v37 Cell 2 voltage (mV). +ve = OK, -ve = channel mismatch	00	V/1000	(2,6,4,2)	1	0	0	3	0	0	0	0	0	0,056		
f4-f11	v38 Cell 3 voltage (mV). +ve = OK, -ve = channel mismatch	00	V/1000	(2,6,4,2)	1	0	0	3	0	0	0	0	0	0,056		
f4-f11	v39 Cell 4 voltage (mV). +ve = OK, -ve = channel mismatch	00	V/1000	(2,6,4,2)	1	0	0	3	0	0	0	0	0	0,056		
f4-f11	v40 Cell 5 voltage (mV). +ve = OK, -ve = channel mismatch	00	V/1000	(2,6,4,2)	1	0	0	3	0	0	0	0	0	0,056		
f4-f11	v41 Cell 6 voltage (mV). +ve = OK, -ve = channel mismatch	00	V/1000	(2,6,4,2)	1	0	0	3	0	0	0	0	0	0,056		
f4-f11	v42 Cell 7 voltage (mV). +ve = OK, -ve = channel mismatch	00	V/1000	(2,6,4,2)	1	0	0	3	0	0	0	0	0	0,056		
f4-f11	v43 Cell 0 voltage (mV). +ve = OK, -ve = channel mismatch	00	V/1000	(2,6,4,2)	1	0	0	3	0	0	0	0	0	0,056		
f4-f11	v44 Cell 1 voltage (mV). +ve = OK, -ve = channel mismatch	00	V/1000	(2,6,4,2)	1	0	0	3	0	0	0	0	0	0,056		
f4-f11	v45 Cell 2 voltage (mV). +ve = OK, -ve = channel mismatch	00	V/1000	(2,6,4,2)	1	0	0	3	0	0	0	0	0	0,056		
f4-f11	v46 Cell 3 voltage (mV). +ve = OK, -ve = channel mismatch	00	V/1000	(2,6,4,2)	1	0	0	3	0	0	0	0	0	0,056		
f4-f11	v47 Cell 4 voltage (mV). +ve = OK, -ve = channel mismatch	00	V/1000	(2,6,4,2)	1	0	0	3	0	0	0	0	0	0,056		
f4-f11	v48 Cell 5 voltage (mV). +ve = OK, -ve = channel mismatch	00	V/1000	(2,6,4,2)	1	0	0	3	0	0	0	0	0	0,056		
f4-f11	v49 Cell 6 voltage (mV). +ve = OK, -ve = channel mismatch	00	V/1000	(2,6,4,2)	1	0	0	3	0	0	0	0	0	0,056		
f4-f11	v50 Cell 7 voltage (mV). +ve = OK, -ve = channel mismatch	00	V/1000	(2,6,4,2)	1	0	0	3	0	0	0	0	0	0,056		
f4-f11	v51 Cell 0 voltage (mV). +ve = OK, -ve = channel mismatch	00	V/1000	(2,6,4,2)	1	0	0	3	0	0	0	0	0	0,056		
f4-f11	v52 Cell 1 voltage (mV). +ve = OK, -ve = channel mismatch	00	V/1000	(2,6,4,2)	1	0	0	3	0	0	0	0	0	0,056		
f4-f11	v53 Cell 2 voltage (mV). +ve = OK, -ve = channel mismatch	00	V/1000	(2,6,4,2)	1	0	0	3	0	0	0	0	0	0,056		
f4-f11	v54 Cell 3 voltage (mV). +ve = OK, -ve = channel mismatch	00	V/1000	(2,6,4,2)	1	0	0	3	0	0	0	0	0	0,056		
f4-f11	v55 Cell 4 voltage (mV). +ve = OK, -ve = channel mismatch	00	V/1000	(2,6,4,2)	1	0	0	3	0	0	0	0	0	0,056		
f4-f11	v56 Cell 5 voltage (mV). +ve = OK, -ve = channel mismatch	00	V/1000	(2,6,4,2)	1	0	0	3	0	0	0	0	0	0,056		
f4-f11	v57 Cell 6 voltage (mV). +ve = OK, -ve = channel mismatch	00	V/1000	(2,6,4,2)	1	0	0	3	0	0	0	0	0	0,056		
f4-f11	v58 Cell 7 voltage (mV). +ve = OK, -ve = channel mismatch	00	V/1000	(2,6,4,2)	1	0	0	3	0	0	0	0	0	0,056		
f4-f11	v59 Cell 0 voltage (mV). +ve = OK, -ve = channel mismatch	00	V/1000	(2,6,4,2)	1	0	0	3	0	0	0	0	0	0,056		
f4-f11	v60 Cell 1 voltage (mV). +ve = OK, -ve = channel mismatch	00	V/1000	(2,6,4,2)	1	0	0	3	0	0	0	0	0	0,056		
f4-f11	v61 Cell 2 voltage (mV). +ve = OK, -ve = channel mismatch	00	V/1000	(2,6,4,2)	1	0	0	3	0	0	0	0	0	0,056		
f4-f11	v62 Cell 3 voltage (mV). +ve = OK, -ve = channel mismatch	00	V/1000	(2,6,4,2)	1	0	0	3	0	0	0	0	0	0,056		
f4-f11	v63 Cell 4 voltage (mV). +ve = OK, -ve = channel mismatch	00	V/1000	(2,6,4,2)	1	0	0	3	0	0	0	0	0	0,056		
f4-f11	v64 Cell 5 voltage (mV). +ve = OK, -ve = channel mismatch	00	V/1000	(2,6,4,2)	1	0	0	3	0	0	0	0	0	0,056		
f4-f11	v65 Cell 6 voltage (mV). +ve = OK, -ve = channel mismatch	00	V/1000	(2,6,4,2)	1	0	0	3	0	0	0	0	0	0,056		
f4-f11	v66 Cell 7 voltage (mV). +ve = OK, -ve = channel mismatch	00	V/1000	(2,6,4,2)	1	0	0	3	0	0	0	0	0	0,056		
f4-f11	v67 Cell 0 voltage (mV). +ve = OK, -ve = channel mismatch	00	V/1000	(2,6,4,2)	1	0	0	3	0	0	0	0	0	0,056		
f4-f11	v68 Cell 1 voltage (mV). +ve = OK, -ve = channel mismatch	00	V/1000	(2,6,4,2)	1	0	0	3	0	0	0	0	0	0,056		
f4-f11	v69 Cell 2 voltage (mV). +ve = OK, -ve = channel mismatch	00	V/1000	(2,6,4,2)	1	0	0	3	0	0	0	0	0	0,056		
f4-f11	v70 Cell 3 voltage (mV). +ve = OK, -ve = channel mismatch	00	V/1000	(2,6,4,2)	1	0	0	3	0	0	0	0	0	0,056		
f4-f11	v71 Cell 4 voltage (mV). +ve = OK, -ve = channel mismatch	00	V/1000	(2,6,4,2)	1	0	0	3	0	0	0	0	0	0,056		
f4-f11	v72 Cell 5 voltage (mV). +ve = OK, -ve = channel mismatch	00	V/1000	(2,6,4,2)	1	0	0	3	0	0	0	0	0	0,056		
f4-f11	v73 Cell 6 voltage (mV). +ve = OK, -ve = channel mismatch	00	V/1000	(2,6,4,2)	1	0	0	3	0	0	0	0	0	0,056		
f4-f11	v74 Cell 7 voltage (mV). +ve = OK, -ve = channel mismatch	00	V/1000	(2,6,4,2)	1	0	0	3	0	0	0	0	0	0,056		
f4-f11	v75 Shows the balancing SOC as a percentage. In other words, the percentage mismatch between cells this session.	10	Ah(%)	(0,100)		0	0	3	0	0	0	0	0	0,056		
f4-f11	v76 Discharging cell voltage error (mV)	00	V/1000	(0,0,1)	10	0	0	3	0	0	0	0	0	0,056		
f4-f11	v77 Minimum / Maximum cell temperature	10	V/1000	(0,60)		0	0	3	0	0	0	0	0	0,056		
f4-f11	v78 CMU number that has the minimum cell temperature	10	0	NA	1	0	0	3	0	0	0	0	0	0,056		
f4-f11	v79 CMU number that has the maximum cell temperature	10	0	NA	1	0	0	3	0	0	0	0	0	0,056		
f11-f6	v80 Bus Current - Desired set point of current drawn from the bus by the controller as a percentage of absolute bus current limit.	01	A	(0,1)	1	0	0	3	0	0	0	0	0	0,056		
f11-f6	v81 DC Bus AmpHours - Charge flow into the controller DC bus from the time of reset.	01	Ah	NA	1	0	0	3	0	0	0	0	0	0,056		
f2'-f11'	v82 Temperature (°C)	00	°C	(30,70)	0	0	0	3	0	0	0	0	0	0,056		

Figure C.5: FDM Matrix for OS<sub>3</sub> of Primavera2 Vehicle - World Solar Challenge 2015

f4-f11	v83	Extended battery pack status	10	0	NA	0	0	0	3	0	1	0	3	0.051
f11-f6	v84	Motor Current -Desired motor current set point as a percentage of maximum current setting.	01	A	(0,30)	4	0	0	0	0	0	0	9	0.042
f11-f6	v85	Receive error count	10	0	NA	5	0	0	0	0	0	0	9	0.042
f11-f6	v86	Transmit error count	10	0	NA	5	0	0	0	0	0	0	9	0.042
f4-f11	v87	Minimum / Maximum cell voltage	00	0	(2,6,4,2)	1	0	0	3	0	0	0	0	0.028
f2-f11	v88	Temp/Temperature of MPPT +-5°C	00	°C	(30,70)	0	0	0	0	3	0	0	0	0.028
f4-f11	v89	PCB temperature ( 1/10th °C)	00	°C	(0,80)	1	0	1	0	0	0	0	0	0.019
f4-f11	v90	Cell temperature ( 1/10th °C)	00	°C	(0,60)	1	0	1	0	0	0	0	0	0.019
f4-f11	v91	PCB temperature ( 1/10th °C)	00	°C	(0,80)	1	0	1	0	0	0	0	0	0.019
f4-f11	v92	Cell temperature ( 1/10th °C)	00	°C	(0,60)	1	0	1	0	0	0	0	0	0.019
f4-f11	v93	PCB temperature ( 1/10th °C)	00	°C	(0,80)	1	0	1	0	0	0	0	0	0.019
f4-f11	v94	Cell temperature ( 1/10th °C)	00	°C	(0,60)	1	0	1	0	0	0	0	0	0.019
f4-f11	v95	PCB temperature ( 1/10th °C)	00	°C	(0,80)	1	0	1	0	0	0	0	0	0.019
f4-f11	v96	Cell temperature ( 1/10th °C)	00	°C	(0,60)	1	0	1	0	0	0	0	0	0.019
f4-f11	v97	PCB temperature ( 1/10th °C)	00	°C	(0,80)	1	0	1	0	0	0	0	0	0.019
f4-f11	v98	Cell temperature ( 1/10th °C)	00	°C	(0,60)	1	0	1	0	0	0	0	0	0.019
f4-f11	v99	Cell temperature margin ( 1/10th °C)	00	°C	(0,1)	10	0	1	0	0	0	0	0	0.019
f4-f11	v100	CMU number that has the minimum cell voltage	10	0	NA	10	0	1	0	0	0	0	0	0.019
f4-f11	v101	CMU number that has the maximum cell voltage	10	0	NA	10	0	1	0	0	0	0	0	0.019
f4-f11	v102	12V current consumption of fans + contactors (mA)	00	V	(0,2000)	1	0	1	0	0	0	0	0	0.019
f4-f11	v103	12V current consumption of CMUs (mA)	00	A/1000	(0,2000)	1	0	1	0	0	0	0	0	0.019
f4-f11	v104	Precharge status, 12V status	10	0	NA	1	0	0	1	0	0	0	0	0.009
f4-f11	v105	12V contactor supply voltage, mV (only on v4 or earlier BMU) for v5 or later BMU, refer to binary bit 0x10 in data_u8[0]	00	V	(0,15)	1	0	0	1	0	0	0	0	0.009
f11-f6	v106	IPM Heat-sink Temp - Internal temperature of Heat-sink in main IPM	00	°C	(0,100)	1	0	0	0	1	0	0	0	0.009
f11-f6	v107	Motor Temp - Internal temperature of the motor.	00	°C	(0,60)	1	0	0	0	1	0	0	0	0.009
f11-f6	v108	Slip Speed - Slip speed when driving an induction motor	00	Hz	(0,100)	5	0	0	0	1	0	0	0	0.009
f4-f11	v109	BMU hardware serial number	10	0	NA	1	0	0	0	0	0	0	0	0.000
f4-f11	v110	Device serial number as programmed at the factory	10	0	NA	1	0	0	0	0	0	0	0	0.000
f4-f11	v111	v5 and later: Device ID: 0x00001000	10	0	NA	1	0	0	0	0	0	0	0	0.000
f4-f11	v112	CMU status, temperature and voltage telemetry, if set to relay to vehicle	20	0	NA	1	0	0	0	0	0	0	0	0.000
f4-f11	v113	CMU # 1 status	20	0	NA	1	0	0	0	0	0	0	0	0.000
f4-f11	v114	CMU serial number (allocated at factory)	10	0	NA	1	0	0	0	0	0	0	0	0.000
f4-f11	v115	CMU # 2 status	20	0	NA	1	0	0	0	0	0	0	0	0.000
f4-f11	v116	CMU serial number (allocated at factory)	10	0	NA	1	0	0	0	0	0	0	0	0.000
f4-f11	v117	CMU # 3 status	20	0	NA	1	0	0	0	0	0	0	0	0.000
f4-f11	v118	CMU serial number (allocated at factory)	10	0	NA	1	0	0	0	0	0	0	0	0.000
f4-f11	v119	CMU # 4 status	20	0	NA	1	0	0	0	0	0	0	0	0.000
f4-f11	v120	CMU serial number (allocated at factory)	10	0	NA	1	0	0	0	0	0	0	0	0.000
f4-f11	v121	CMU # 5 status	20	0	NA	1	0	0	0	0	0	0	0	0.000
f4-f11	v122	CMU serial number (allocated at factory)	10	0	NA	1	0	0	0	0	0	0	0	0.000
f4-f11	v123	Reserved for factory configuration & calibration commands	11	0	NA	1	0	0	0	0	0	0	0	0.000
f4-f11	v124	Reserved for future configuration system update	11	0	NA	1	0	0	0	0	0	0	0	0.000
f4-f11	v125	Charger Control Information	10	0	NA	0	0	0	0	0	0	0	0	0.000
f4-f11	v126	Charging cell voltage error (mV)	00	V/1000	(0,100)	10	0	0	0	0	0	0	0	0.000
f4-f11	v127	Precharge contactor driver status	20	0	NA	1	0	0	0	0	0	0	0	0.000
f4-f11	v128	Precharge state (in order of normal appearance when starting)	20	0	NA	1	0	0	0	0	0	0	0	0.000
f4-f11	v129	Unused, reports as 0x0000	10	0	NA	1	0	0	0	0	0	0	0	0.000
f4-f11	v130	0x01 = Precharge timer elapsed (Don't care if timeout disabled) 0x00 = Precharge timer not elapsed	00	s	NA	1	0	0	0	0	0	0	0	0.000
f4-f11	v131	7] Precharge timer counter (10ms per count)	00	s/1000	NA	1	0	0	0	0	0	0	0	0.000
f4-f11	v132	Unused, reads as 0x00	10	0	NA	1	0	0	0	0	0	0	0	0.000
f4-f11	v133	Unused, reads as 0x00	10	0	NA	1	0	0	0	0	0	0	0	0.000
f4-f11	v134	Balance voltage threshold - rising (balance resistor turns on)	11	V/1000	(4100)	1	0	0	0	0	0	0	0	0.000
f4-f11	v135	Balance voltage threshold - falling (balance resistor turns off)	11	V/1000	(4050)	1	0	0	0	0	0	0	0	0.000
f4-f11	v136	BMS CMU count	10	0	NA	1	0	0	0	0	0	0	0	0.000
f4-f11	v137	BMS BMU Firmware Build Number	10	0	NA	1	0	0	0	0	0	0	0	0.000
f4-f11	v138	Fan & 12V supply status	20	0	NA	1	0	0	0	0	0	0	0	0.000
f4-f11	v139	Fan speed 0 (rpm)	00	rpm	(0,2000)	1	0	0	0	0	0	0	0	0.000
f4-f11	v140	Fan speed 1 (rpm)	00	rpm	(0,2000)	1	0	0	0	0	0	0	0	0.000
f4-f11	v141	BMU Hardware version	10	0	NA	1	0	0	0	0	0	0	0	0.000
f4-f11	v142	BMU Model ID	10	0	NA	1	0	0	0	0	0	0	0	0.000
f4-f11	v143	Unused	10	0	NA	1	0	0	0	0	0	0	0	0.000
f11-f6	v144	Unused	10	0	NA	1	0	0	0	0	0	0	0	0.000
f11-f6	v145	Unused	10	0	NA	1	0	0	0	0	0	0	0	0.000
f11-f6	v146	Serial Number -Device serial number, allocated at manufacture	10	0	NA	1	0	0	0	0	0	0	0	0.000
f11-f6	v147	Tritium ID - "T088" stored as a string. msg[0] = 'T', msg[1] = '0'...	10	0	NA	1	0	0	0	0	0	0	0	0.000
f11-f6	v148	Active Motor	10	0	(0,10)	5	0	0	0	0	0	0	0	0.000
f11-f6	v149	Motor Velocity - Motor angular frequency in revolutions per minute	00	rpm	(0,2000)	5	0	0	0	0	0	0	0	0.000
f11-f6	v150	Phase C Current Arms RMS current in motor Phase C	00	Arms	(0,60)	5	0	0	0	0	0	0	0	0.000
f11-f6	v151	Phase B Current - RMS current in motor Phase B.	00	Arms	(0,60)	5	0	0	0	0	0	0	0	0.000
f11-f6	v152	Real component of the applied non-rotating voltage vector to the motor.	00	V	(0,147)	5	0	0	0	0	0	0	0	0.000
f11-f6	v153	Imaginary component of the applied non-rotating voltage vector to the motor.	00	V	(0,147)	5	0	0	0	0	0	0	0	0.000
f11-f6	v154	Real component of the applied non-rotating current vector to the motor. This vector represents the field current of the motor.	00	A	(0,60)	5	0	0	0	0	0	0	0	0.000
f11-f6	v155	Imaginary component of the applied non-rotating current vector to the motor. This current produces torque in the motor and should be in phase with the back-EMF of the motor.	00	A	(0,60)	5	0	0	0	0	0	0	0	0.000
f11-f6	v156	BEMFd -By definition this value is always 0V	00	V	(0)	5	0	0	0	0	0	0	0	0.000
f11-f6	v157	BEMFq - The peak of the phase to neutral motor voltage.	00	V	(0)	5	0	0	0	0	0	0	0	0.000
f11-f6	v158	15V supply - Actual voltage level of the 15V power rail.	00	V	(12,15)	1	0	0	0	0	0	0	0	0.000
f11-f6	v159	Reserved	10	0	NA	1	0	0	0	0	0	0	0	0.000
f11-f6	v160	3.3V supply - Actual voltage level of the 3.3V power rail	00	V	(3,1,3,3)	1	0	0	0	0	0	0	0	0.000
f11-f6	v161	1.9V supply - Actual voltage level of the 1.9V DSP power rail.	00	V	(1,8,1,9)	1	0	0	0	0	0	0	0	0.000
f11-f6	v162	Reserved	10	0	NA	1	0	0	0	0	0	0	0	0.000
f11-f6	v163	Reserved	10	0	NA	1	0	0	0	0	0	0	0	0.000
f11-f6	v164	Reserved	10	0	NA	1	0	0	0	0	0	0	0	0.000
f11-f6	v165	DSP Board Temp - Temperature of the DSP board.	00	°C	(0,60)	1	0	0	0	0	0	0	0	0.000
f11-f6	v166	Reserved	10	0	NA	1	0	0	0	0	0	0	0	0.000
f11-f6	v167	Reserved	10	0	NA	1	0	0	0	0	0	0	0	0.000
f11-f6	v168	Reserved	10	0	NA	5	0	0	0	0	0	0	0	0.000
f2-f11	v169	NDC - No Charge Flag (0= Battery Connected, 1=Battery Disconnected)	20	0	NA	0	0	0	0	0	0	0	0	0.000

Figure C.6: FDM Matrix (continuation) for OS<sub>3</sub> of Primavera2 Vehicle - World Solar Challenge 2015

FLOWS	VARIABLE	ATTRIBUTES				BASIC FUNCTIONS										Variable Relevance
		alpha	Beta	Gamma	Delta (Hz)	To maintain Structural Integrity	To provide Life Support	To store Energy	To recover kinetic energy	To collect energy from the sun	to perform driving actions	to send vehicle data to crew	to calculate speed setpoint			
						F14	F15	F17	F19	F110	F112	F113	F114	OS'n		
						0,25	0,25	0,16666667	0,08333333	0,08333333	0,08333333	0,04166667	0,04166667	wfu		
f4-f11	v1 Battery pack voltage & current					0	0	9	9	9	3	0	9	0,250		
f4-f11	v2 Battery Voltage (mV)					0	0	9	9	9	3	0	9	0,250		
f4-f11	v3 Battery Current (mA)	01	A	V/1000 (90,147)	10	0	0	9	9	9	3	0	9	0,194		
f4-f11	v4 Pack SOC					0	0	9	9	3	3	0	9	0,194		
f4-f11	v5 SOC (Ah) Shows Ah consumed from the pack. 0 = Full, and counts upwards towards the user-set pack capacity number as Ah are used. Resets to 0 when max cell reaches balance threshold.		Ah	(0,40,8)	1	0	0	9	9	3	3	0	9	0,194		
f4-f11	v6 Shows the SOC as a percentage. 100% = full, 0% = empty	10		(0,100)	1	0	0	9	9	3	3	0	9	0,194		
f2-f11'	v7 Battery Voltage (mV)	00	V	V/1000 (90,147)	0	0	0	9	9	3	3	0	9	0,194		
f2-f11'	v8 Battery Current (mA)	01	A	(0,20,5)	0	0	0	9	9	3	3	0	9	0,194		
f4-f11	v9 Maximum cell voltage (mV)	00	V	V/1000 (2,6,4,2)	10	0	0	9	9	3	3	0	9	0,194		
f11-f6	v10 Bus Voltage - DC bus voltage at the controller.	00	V	V/1000 (90,147)	5	0	0	9	9	3	3	0	9	0,194		
f2-f11'	v11 Capacity (mAh)	00	Ah	1000 (0,40,8)	0	0	0	9	3	3	3	0	9	0,194		
f4-f11	v12 Minimum cell voltage (mV)	00	V	V/1000 (2,6,4,2)	10	0	0	9	3	3	3	0	9	0,194		
f4-f11	v13 Status Flags	10	0	NA	1	0	0	9	3	3	3	0	9	0,194		
f4-f11	v14 Uout(output Voltage)	00	V	(90,147)	0	0	0	9	0	0	0	0	9	0,250		
f4-f11	v15 Total pack capacity (Ah)	00	Ah	(0,40,8)	10	0	0	9	3	0	0	0	9	0,167		
f4-f11	v16 Status Flags	10	0	NA	1	0	0	9	3	0	3	0	9	0,167		
f2-f11	v17 BTLR - Battery Voltage Level Reached Flag (0= Uout<UoutMax, 1=Uout=UoutMax)	20	V	NA	0	0	0	3	9	9	0	0	0	0,139		
f2-f11	v18 BTLR - Battery Voltage Level Reached Flag (0= Uout<UoutMax, 1=Uout=UoutMax)	20	V	NA	0	0	0	3	9	9	0	0	0	0,139		
f4-f11	v19 Battery pack status	00	0	NA	1	0	0	9	0	3	1	0	3	0,194		
f11-f6	v20 Odometer - Distance the vehicle has travelled since reset.	00	m	NA	1	0	0	0	0	9	9	0	9	0,083		
f11-f6	v21 Bus Current - Current drawn from the DC bus by the controller.	00	A	(0,20,5)	0	0	0	9	0	0	0	0	9	0,167		
f4-f11	v22 Maximum cell temperature (1/10th °C)	00	°C	'10 (20,55)	1	0	0	9	0	0	0	0	1	0,167		
f4-f11	v23 Cell number in CMU that is the minimum cell voltage	10	V	V/1000 NA	10	0	0	9	0	0	0	0	0	0,167		
f4-f11	v24 Cell number in CMU that is the maximum cell voltage	10	V	V/1000 NA	10	0	0	9	0	0	0	0	0	0,167		
f11-f6	v25 Error Flags	20	0	NA	5	0	0	9	0	0	9	0	9	0,000		
f11-f6	v26 Limit Flags	10	0	NA	5	0	0	9	0	0	9	0	9	0,000		
f11-f6	v27 Vehicle Velocity - Vehicle velocity in metres / second	01	ms	(16,6, 33,3)	5	0	0	0	3	0	9	0	9	0,000		
f2-f11	v28 Iin(Input Current)	00	A	(0,4)	0	0	0	0	3	9	0	0	9	0,083		
f2-f11	v29 Vin (Input Voltage)	00	V	(36-141,4)	0	0	0	0	0	9	0	0	9	0,083		
f2-f11	v30 OVT - Overtemperature Flag (0= Temp<95°C, 1=Temp>=95°C)	20	°C	NA	0	0	0	0	0	0	0	0	0	0,083		
f11-f6	v31 Motor Velocity (rpm) Desired motor velocity set point in rpm	01	(pi/30)ka div	(850,1100)	4	0	0	0	1	0	3	0	9	0,000		
f4-f11	v32 Balance SOC					0	0	3	0	0	0	0	3	0,056		
f4-f11	v33 Balance SOC (Ah) Shows Ah supplied to the pack since the first cell began balancing. This number will continue to count up until all cells in the pack are balancing, therefore showing the Ah mismatch that has been corrected during this balancing session.	00	Ah	(0,40,8)	1	0	0	3	0	0	0	0	3	0,056		
f4-f11	v34 Minimum cell temperature (1/10th °C)	20	0	NA	1	0	0	3	0	0	0	0	1	0,056		
f4-f11	v35 Cell 0 voltage (mV) +ve - OK, -ve - channel mismatch	00	V	V/1000 (2,6,4,2)	1	0	0	3	0	0	0	0	0	0,056		
f4-f11	v36 Cell 1 voltage (mV) +ve - OK, -ve - channel mismatch	00	V	V/1000 (2,6,4,2)	1	0	0	3	0	0	0	0	0	0,056		
f4-f11	v37 Cell 2 voltage (mV) +ve - OK, -ve - channel mismatch	00	V	V/1000 (2,6,4,2)	1	0	0	3	0	0	0	0	0	0,056		
f4-f11	v38 Cell 3 voltage (mV) +ve - OK, -ve - channel mismatch	00	V	V/1000 (2,6,4,2)	1	0	0	3	0	0	0	0	0	0,056		
f4-f11	v39 Cell 4 voltage (mV) +ve - OK, -ve - channel mismatch	00	V	V/1000 (2,6,4,2)	1	0	0	3	0	0	0	0	0	0,056		
f4-f11	v40 Cell 5 voltage (mV) +ve - OK, -ve - channel mismatch	00	V	V/1000 (2,6,4,2)	1	0	0	3	0	0	0	0	0	0,056		
f4-f11	v41 Cell 6 voltage (mV) +ve - OK, -ve - channel mismatch	00	V	V/1000 (2,6,4,2)	1	0	0	3	0	0	0	0	0	0,056		
f4-f11	v42 Cell 7 voltage (mV) +ve - OK, -ve - channel mismatch	00	V	V/1000 (2,6,4,2)	1	0	0	3	0	0	0	0	0	0,056		
f4-f11	v43 Cell 0 voltage (mV) +ve - OK, -ve - channel mismatch	00	V	V/1000 (2,6,4,2)	1	0	0	3	0	0	0	0	0	0,056		
f4-f11	v44 Cell 1 voltage (mV) +ve - OK, -ve - channel mismatch	00	V	V/1000 (2,6,4,2)	1	0	0	3	0	0	0	0	0	0,056		
f4-f11	v45 Cell 2 voltage (mV) +ve - OK, -ve - channel mismatch	00	V	V/1000 (2,6,4,2)	1	0	0	3	0	0	0	0	0	0,056		
f4-f11	v46 Cell 3 voltage (mV) +ve - OK, -ve - channel mismatch	00	V	V/1000 (2,6,4,2)	1	0	0	3	0	0	0	0	0	0,056		
f4-f11	v47 Cell 4 voltage (mV) +ve - OK, -ve - channel mismatch	00	V	V/1000 (2,6,4,2)	1	0	0	3	0	0	0	0	0	0,056		
f4-f11	v48 Cell 5 voltage (mV) +ve - OK, -ve - channel mismatch	00	V	V/1000 (2,6,4,2)	1	0	0	3	0	0	0	0	0	0,056		
f4-f11	v49 Cell 6 voltage (mV) +ve - OK, -ve - channel mismatch	00	V	V/1000 (2,6,4,2)	1	0	0	3	0	0	0	0	0	0,056		
f4-f11	v50 Cell 7 voltage (mV) +ve - OK, -ve - channel mismatch	00	V	V/1000 (2,6,4,2)	1	0	0	3	0	0	0	0	0	0,056		
f4-f11	v51 Cell 0 voltage (mV) +ve - OK, -ve - channel mismatch	00	V	V/1000 (2,6,4,2)	1	0	0	3	0	0	0	0	0	0,056		
f4-f11	v52 Cell 1 voltage (mV) +ve - OK, -ve - channel mismatch	00	V	V/1000 (2,6,4,2)	1	0	0	3	0	0	0	0	0	0,056		
f4-f11	v53 Cell 2 voltage (mV) +ve - OK, -ve - channel mismatch	00	V	V/1000 (2,6,4,2)	1	0	0	3	0	0	0	0	0	0,056		
f4-f11	v54 Cell 3 voltage (mV) +ve - OK, -ve - channel mismatch	00	V	V/1000 (2,6,4,2)	1	0	0	3	0	0	0	0	0	0,056		
f4-f11	v55 Cell 4 voltage (mV) +ve - OK, -ve - channel mismatch	00	V	V/1000 (2,6,4,2)	1	0	0	3	0	0	0	0	0	0,056		
f4-f11	v56 Cell 5 voltage (mV) +ve - OK, -ve - channel mismatch	00	V	V/1000 (2,6,4,2)	1	0	0	3	0	0	0	0	0	0,056		
f4-f11	v57 Cell 6 voltage (mV) +ve - OK, -ve - channel mismatch	00	V	V/1000 (2,6,4,2)	1	0	0	3	0	0	0	0	0	0,056		
f4-f11	v58 Cell 7 voltage (mV) +ve - OK, -ve - channel mismatch	00	V	V/1000 (2,6,4,2)	1	0	0	3	0	0	0	0	0	0,056		
f4-f11	v59 Cell 0 voltage (mV) +ve - OK, -ve - channel mismatch	00	V	V/1000 (2,6,4,2)	1	0	0	3	0	0	0	0	0	0,056		
f4-f11	v60 Cell 1 voltage (mV) +ve - OK, -ve - channel mismatch	00	V	V/1000 (2,6,4,2)	1	0	0	3	0	0	0	0	0	0,056		
f4-f11	v61 Cell 2 voltage (mV) +ve - OK, -ve - channel mismatch	00	V	V/1000 (2,6,4,2)	1	0	0	3	0	0	0	0	0	0,056		
f4-f11	v62 Cell 3 voltage (mV) +ve - OK, -ve - channel mismatch	00	V	V/1000 (2,6,4,2)	1	0	0	3	0	0	0	0	0	0,056		
f4-f11	v63 Cell 4 voltage (mV) +ve - OK, -ve - channel mismatch	00	V	V/1000 (2,6,4,2)	1	0	0	3	0	0	0	0	0	0,056		
f4-f11	v64 Cell 5 voltage (mV) +ve - OK, -ve - channel mismatch	00	V	V/1000 (2,6,4,2)	1	0	0	3	0	0	0	0	0	0,056		
f4-f11	v65 Cell 6 voltage (mV) +ve - OK, -ve - channel mismatch	00	V	V/1000 (2,6,4,2)	1	0	0	3	0	0	0	0	0	0,056		
f4-f11	v66 Cell 7 voltage (mV) +ve - OK, -ve - channel mismatch	00	V	V/1000 (2,6,4,2)	1	0	0	3	0	0	0	0	0	0,056		
f4-f11	v67 Cell 0 voltage (mV) +ve - OK, -ve - channel mismatch	00	V	V/1000 (2,6,4,2)	1	0	0	3	0	0	0	0	0	0,056		
f4-f11	v68 Cell 1 voltage (mV) +ve - OK, -ve - channel mismatch	00	V	V/1000 (2,6,4,2)	1	0	0	3	0	0	0	0	0	0,056		
f4-f11	v69 Cell 2 voltage (mV) +ve - OK, -ve - channel mismatch	00	V	V/1000 (2,6,4,2)	1	0	0	3	0	0	0	0	0	0,056		
f4-f11	v70 Cell 3 voltage (mV) +ve - OK, -ve - channel mismatch	00	V	V/1000 (2,6,4,2)	1	0	0	3	0	0	0	0	0	0,056		
f4-f11	v71 Cell 4 voltage (mV) +ve - OK, -ve - channel mismatch	00	V	V/1000 (2,6,4,2)	1	0	0	3	0	0	0	0	0	0,056		
f4-f11	v72 Cell 5 voltage (mV) +ve - OK, -ve - channel mismatch	00	V	V/1000 (2,6,4,2)	1	0	0	3	0	0	0	0	0	0,056		
f4-f11	v73 Cell 6 voltage (mV) +ve - OK, -ve - channel mismatch	00	V	V/1000 (2,6,4,2)	1	0	0	3	0	0	0	0	0	0,056		
f4-f11	v74 Cell 7 voltage (mV) +ve - OK, -ve - channel mismatch	00	V	V/1000 (2,6,4,2)	1	0	0	3	0	0	0	0	0	0,056		
f4-f11	v75 Shows the balancing SOC as a percentage, in other words, the percentage mismatch between cells this session.	10	Ah(%)	(0,100)	0	0	0	0	0	0	0	0	0	0,056		
f4-f11	v76 Discharging cell voltage error (mV)	00	V	V/1000 (0,0,1)	10	0	0	3	0	0	0	0	0	0,056		
f4-f11	v77 Minimum / Maximum cell temperature	10	V	V/1000 (0,60)	0	0	0	3	0	0	0	0	0	0,056		
f4-f11	v78 CMU number that has the minimum cell temperature	10	0	NA	1	0	0	3	0	0	0	0	0	0,056		
f4-f11	v79 CMU number that has the maximum cell temperature	10	0	NA	1	0	0	3	0	0	0	0	0	0,056		
f11-f6	v80 Bus Current - Desired set point of current drawn from the bus by the controller as a percentage of absolute bus current limit.	01	A	(0,1)	1	0	0	0	3	0	0	0	0	0,056		
f11-f6	v81 DC Bus AmpHours - Charge flow into the controller DC bus from the time of reset.	01	Ah	NA	1	0	0	0	3	0	0	0	0	0,056		
f2-f11'	v82 Temperature (°C)	00	°C	(30,70)	0	0	0	3	0	0	0	0	0	0,056		

Figure C.7: FDM Matrix for OS<sub>4</sub> of Primavera2 Vehicle - World Solar Challenge 2015

f4-f11	v83	Extended battery pack status	10	0	NA	0	0	0	0	3	0	1	0	3	0.000
f11-f6	v84	Motor Current - Desired motor current set point as a percentage of maximum current setting	01	A	(0,30)	4	0	0	0	0	0	0	0	9	0.000
f11-f6	v85	Receive error count	10	0	NA	5	0	0	0	0	0	0	0	9	0.042
f11-f6	v86	Transmit error count	10	0	NA	5	0	0	0	0	0	0	0	9	0.042
f4-f11	v87	Minimum / Maximum cell voltage	00	0	(2,6A,2)	1	0	0	0	3	0	0	0	0	0.000
f4-f11	v88	Temp(Temperature of MPPT +5°C)	00	°C	(30,70)	0	0	0	0	3	0	0	0	0	0.028
f4-f11	v89	PCB temperature (1/10th °C)	00	°C	(0,80)	1	0	0	1	0	0	0	0	0	0.019
f4-f11	v90	Cell temperature (1/10th °C)	00	°C	(0,60)	1	0	0	1	0	0	0	0	0	0.019
f4-f11	v91	PCB temperature (1/10th °C)	00	°C	(0,80)	1	0	0	1	0	0	0	0	0	0.019
f4-f11	v92	Cell temperature (1/10th °C)	00	°C	(0,60)	1	0	0	1	0	0	0	0	0	0.019
f4-f11	v93	PCB temperature (1/10th °C)	00	°C	(0,80)	1	0	0	1	0	0	0	0	0	0.019
f4-f11	v94	Cell temperature (1/10th °C)	00	°C	(0,60)	1	0	0	1	0	0	0	0	0	0.019
f4-f11	v95	PCB temperature (1/10th °C)	00	°C	(0,80)	1	0	0	1	0	0	0	0	0	0.019
f4-f11	v96	Cell temperature (1/10th °C)	00	°C	(0,60)	1	0	0	1	0	0	0	0	0	0.019
f4-f11	v97	PCB temperature (1/10th °C)	00	°C	(0,80)	1	0	0	1	0	0	0	0	0	0.019
f4-f11	v98	Cell temperature (1/10th °C)	00	°C	(0,60)	1	0	0	1	0	0	0	0	0	0.019
f4-f11	v99	Cell temperature margin (1/10th °C)	00	°C	(0,1)	10	0	0	1	0	0	0	0	0	0.019
f4-f11	v100	CMU number that has the minimum cell voltage	10	0	NA	10	0	0	1	0	0	0	0	0	0.019
f4-f11	v101	CMU number that has the maximum cell voltage	10	0	NA	10	0	0	1	0	0	0	0	0	0.019
f4-f11	v102	12V current consumption of fans + contactors (mA)	00	V	(0,2000)	1	0	0	1	0	0	0	0	0	0.019
f4-f11	v103	12V current consumption of CMUs (mA)	00	A/1000	(0,2000)	1	0	0	1	0	0	0	0	0	0.019
f4-f11	v104	Precharge status, 12V status	10	0	NA	1	0	0	0	1	0	0	0	0	0.000
f4-f11	v105	12V contactor supply voltage, mV (only on v4 or earlier BMU) for v5 or later BMU. refer to binary bit (x10) in data sheet)	00	V	(0,15)	1	0	0	0	1	0	0	0	0	0.000
f11-f6	v106	IPM Heat-sink Temp - Internal temperature of Heat-sink in main IPM	00	°C	(0,100)	1	0	0	0	1	0	0	0	0	0.000
f11-f6	v107	Motor Temp - Internal temperature of the motor.	00	°C	(0,60)	1	0	0	0	1	0	0	0	0	0.000
f11-f6	v108	Slip Speed - Slip speed when driving an induction motor	00	Hz	(0,100)	5	0	0	0	1	0	0	0	0	0.000
f4-f11	v109	BMU heartbeat & serial number	10	0	NA	1	0	0	0	0	0	0	0	0	0.000
f4-f11	v110	Device serial number as programmed at the factory	10	0	NA	1	0	0	0	0	0	0	0	0	0.000
f4-f11	v111	v5 and later: Device ID: (0x0001000)	10	0	NA	1	0	0	0	0	0	0	0	0	0.000
f4-f11	v112	CMU status, temperature and voltage telemetry, if set to relay to vehicle	20	0	NA	1	0	0	0	0	0	0	0	0	0.000
f4-f11	v113	CMU # 1 status	20	0	NA	1	0	0	0	0	0	0	0	0	0.000
f4-f11	v114	CMU serial number (allocated at factory)	10	0	NA	1	0	0	0	0	0	0	0	0	0.000
f4-f11	v115	CMU # 2 status	20	0	NA	1	0	0	0	0	0	0	0	0	0.000
f4-f11	v116	CMU serial number (allocated at factory)	10	0	NA	1	0	0	0	0	0	0	0	0	0.000
f4-f11	v117	CMU # 3 status	20	0	NA	1	0	0	0	0	0	0	0	0	0.000
f4-f11	v118	CMU serial number (allocated at factory)	10	0	NA	1	0	0	0	0	0	0	0	0	0.000
f4-f11	v119	CMU # 4 status	20	0	NA	1	0	0	0	0	0	0	0	0	0.000
f4-f11	v120	CMU serial number (allocated at factory)	10	0	NA	1	0	0	0	0	0	0	0	0	0.000
f4-f11	v121	CMU # 5 status	20	0	NA	1	0	0	0	0	0	0	0	0	0.000
f4-f11	v122	CMU serial number (allocated at factory)	10	0	NA	1	0	0	0	0	0	0	0	0	0.000
f4-f11	v123	Reserved for factory configuration & calibration commands	11	0	NA	1	0	0	0	0	0	0	0	0	0.000
f4-f11	v124	Reserved for future configuration system update	11	0	NA	1	0	0	0	0	0	0	0	0	0.000
f4-f11	v125	Charger Control information	10	0	NA	0	0	0	0	0	0	0	0	0	0.000
f4-f11	v126	Charging cell voltage error (mV).	00	V/1000	(0,100)	10	0	0	0	0	0	0	0	0	0.000
f4-f11	v127	Precharge contactor driver status	20	0	NA	1	0	0	0	0	0	0	0	0	0.000
f4-f11	v128	Precharge state (in order of normal appearance when starting)	20	0	NA	1	0	0	0	0	0	0	0	0	0.000
f4-f11	v129	Unused, reports as 0x000	10	0	NA	1	0	0	0	0	0	0	0	0	0.000
f4-f11	v130	(0x1) - Precharge timer elapsed (Don't care if timeout disabled) (0x0) - Precharge timer not elapsed	00	s	NA	1	0	0	0	0	0	0	0	0	0.000
f4-f11	v131	T1 Precharge timer counter (10ms per count)	00	s/1000	NA	1	0	0	0	0	0	0	0	0	0.000
f4-f11	v132	Unused, reads as 0x00	10	0	NA	1	0	0	0	0	0	0	0	0	0.000
f4-f11	v133	Unused, reads as 0x00	10	0	NA	1	0	0	0	0	0	0	0	0	0.000
f4-f11	v134	Balance voltage threshold - rising (balance resistor turns on)	11	V/1000	(4,100)	1	0	0	0	0	0	0	0	0	0.000
f4-f11	v135	Balance voltage threshold - falling (balance resistor turns off)	11	V/1000	(4,050)	1	0	0	0	0	0	0	0	0	0.000
f4-f11	v136	BMS CMU count	10	0	NA	1	0	0	0	0	0	0	0	0	0.000
f4-f11	v137	BMS BMU Firmware Build Number	10	0	NA	1	0	0	0	0	0	0	0	0	0.000
f4-f11	v138	Fan & 12V supply status	20	0	NA	1	0	0	0	0	0	0	0	0	0.000
f4-f11	v139	Fan speed 0 (rpm)	00	rpm	(0,2000)	1	0	0	0	0	0	0	0	0	0.000
f4-f11	v140	Fan speed 1 (rpm)	00	rpm	(0,2000)	5	0	0	0	0	0	0	0	0	0.000
f4-f11	v141	BMU Hardware version	10	0	NA	1	0	0	0	0	0	0	0	0	0.000
f4-f11	v142	BMU Model ID	10	0	NA	1	0	0	0	0	0	0	0	0	0.000
f4-f11	v143	Unused	10	0	NA	1	0	0	0	0	0	0	0	0	0.000
f4-f11	v144	Unused	10	0	NA	1	0	0	0	0	0	0	0	0	0.000
f11-f6	v145	Unused	10	0	NA	1	0	0	0	0	0	0	0	0	0.000
f11-f6	v146	Serial Number - Device serial number, allocated at manufacture	10	0	NA	1	0	0	0	0	0	0	0	0	0.000
f11-f6	v147	Tritium ID - "T088" stored as a string, msg[0] - 'T', msg[1] - '0'...	10	0	NA	1	0	0	0	0	0	0	0	0	0.000
f11-f6	v148	Active Motor	10	0	(0,10)	5	0	0	0	0	0	0	0	0	0.000
f11-f6	v149	Motor Velocity - Motor angular frequency in revolutions per minute	00	rpm	(0,2000)	5	0	0	0	0	0	0	0	0	0.000
f11-f6	v150	Phase C Current Arms RMS current in motor Phase C	00	Arms	(0,60)	5	0	0	0	0	0	0	0	0	0.000
f11-f6	v151	Phase B Current - RMS current in motor Phase B	00	Arms	(0,147)	5	0	0	0	0	0	0	0	0	0.000
f11-f6	v152	Real component of the applied non-rotating voltage vector to the motor.	00	V	(0,147)	5	0	0	0	0	0	0	0	0	0.000
f11-f6	v153	Imaginary component of the applied non-rotating voltage vector to the motor.	00	V	(0,147)	5	0	0	0	0	0	0	0	0	0.000
f11-f6	v154	Real component of the applied non-rotating current vector to the motor. This vector represents the field current of the motor	00	A	(0,60)	5	0	0	0	0	0	0	0	0	0.000
f11-f6	v155	Imaginary component of the applied non-rotating current vector to the motor. This current produces torque in the motor and should be in phase with the back-EMF of the motor.	00	A	(0,60)	5	0	0	0	0	0	0	0	0	0.000
f11-f6	v156	BEMF - By definition this value is always 0V	00	V	(0)	5	0	0	0	0	0	0	0	0	0.000
f11-f6	v157	BEMFq - The peak of the phase to neutral motor voltage.	00	V	(0)	5	0	0	0	0	0	0	0	0	0.000
f11-f6	v158	15V supply - Actual voltage level of the 15V power rail.	00	V	(12,15)	1	0	0	0	0	0	0	0	0	0.000
f11-f6	v159	Reserved	10	0	NA	1	0	0	0	0	0	0	0	0	0.000
f11-f6	v160	3.3V supply - Actual voltage level of the 3.3V power rail	00	V	(3,3,3.3)	1	0	0	0	0	0	0	0	0	0.000
f11-f6	v161	1.9V supply - Actual voltage level of the 1.9V DSP power rail.	00	V	(1,8,1.9)	1	0	0	0	0	0	0	0	0	0.000
f11-f6	v162	Reserved	10	0	NA	1	0	0	0	0	0	0	0	0	0.000
f11-f6	v163	Reserved	10	0	NA	1	0	0	0	0	0	0	0	0	0.000
f11-f6	v164	Reserved	10	0	NA	1	0	0	0	0	0	0	0	0	0.000
f11-f6	v165	DSP Board Temp - Temperature of the DSP board.	00	°C	(0,60)	1	0	0	0	0	0	0	0	0	0.000
f11-f6	v166	Reserved	10	0	NA	1	0	0	0	0	0	0	0	0	0.000
f11-f6	v167	Reserved	10	0	NA	1	0	0	0	0	0	0	0	0	0.000
f11-f6	v168	Reserved	10	0	NA	5	0	0	0	0	0	0	0	0	0.000
f2-f11	v169	NOC - No Charge Flag (0 - Battery Connected, 1 - Battery Disconnected)	20	0	NA	0	0	0	0	0	0	0	0	0	0.000

Figure C.8: FDM Matrix (continuation) for OS4 of Primavera2 Vehicle - World Solar Challenge 2015

VARIABLE	IDLE STATE	RUN. NO GENERATION	RUN. GENERATION	STOP. CHARGING
	OS1	OS2	OS3	OS4
v1 Battery pack voltage & current	0	0,319444444	0,402777778	0,25
v2 Battery Voltage (mV)	0	0,319444444	0,402777778	0,25
v3 Battery Current (mA)	0	0,319444444	0,402777778	0,25
v4 Pack SOC	0	0,319444444	0,347222222	0,194444444
v5 SOC (Ah). Shows Ah consumed from the pack. 0 = Full, and counts upwards towards the user-set pack capacity number as Ah are used. Resets to 0 when max cell reaches balance threshold.	0	0,319444444	0,347222222	0,194444444
v6 Shows the SOC as a percentage. 100% = full, 0% = empty	0	0,319444444	0,347222222	0,194444444
v7 Battery Voltage (mV)	0	0,319444444	0,347222222	0,194444444
v8 Battery Current	0	0,319444444	0,347222222	0,194444444
v9 Maximum cell voltage (mV)	0	0,291666667	0,319444444	0,194444444
v10 Bus Voltage - DC bus voltage at the controller.	0	0,263888889	0,291666667	0,194444444
v11 Capacity (mAh)	0	0,24537037	0,273148148	0,194444444
v12 Minimum cell voltage (mV)	0	0,236111111	0,263888889	0,194444444
v13 Status Flags	0	0,236111111	0,263888889	0,194444444
v14 Uout(output Voltage)	0	0,166666667	0,25	0,25
v15 Total pack capacity (Ah)	0	0,236111111	0,236111111	0,166666667
v16 Status Flags	0	0,236111111	0,236111111	0,166666667
v17 BVLR- Battery Voltage Level Reached Flag (0=Uout<UoutMax, 1=Uout=UoutMax)	0	0,138888889	0,222222222	0,138888889
v18 BVLR- Battery Voltage Level Reached Flag (0=Uout<UoutMax, 1=Uout=UoutMax)	0	0,138888889	0,222222222	0,138888889
v19 Battery pack status	0	0,189814815	0,217592593	0,194444444
v20 Odometer - Distance the vehicle has travelled since reset.	0	0,125	0,208333333	0,083333333
v21 Bus Current - Current drawn from the DC bus by the controller.	0	0,180555556	0,180555556	0,166666667
v22 Maximum cell temperature ( 1/10th °C)	0	0,171296296	0,171296296	0,166666667
v23 Cell number in CMU that is the minimum cell voltage	0	0,166666667	0,166666667	0,166666667
v24 Cell number in CMU that is the maximum cell voltage	0	0,166666667	0,166666667	0,166666667
v25 Error Flags	0	0,166666667	0,166666667	0
v26 Limit Flags	0	0,166666667	0,166666667	0
v27 Vehicle Velocity- Vehicle velocity in metres / second	0	0,152777778	0,152777778	0
v28 Iin(Input Current)	0	0,069444444	0,152777778	0,083333333
v29 Uin (Input Voltage)	0	0,041666667	0,125	0,083333333
v30 OVT- Overtemperature Flag (0= Temp<95°C, 1=Temp>=95°C)	0	0	0,083333333	0,083333333
v31 Motor Velocity (rpm) Desired motor velocity set point in rpm	0	0,078703704	0,078703704	0
v32 Balance SOC	0	0,069444444	0,069444444	0,055555556
v33 Balance SOC (Ah). Shows Ah supplied to the pack since the first cell began balancing. This number will continue to count up until all cells in the pack are balancing, therefore showing the Ah mismatch that has been corrected during this balancing session.	0	0,069444444	0,069444444	0,055555556
v34 Minimum cell temperature ( 1/10th °C)	0	0,060185185	0,060185185	0,055555556
v35 Cell 0 voltage (mV). +ve = OK, -ve = channel mismatch	0	0,055555556	0,055555556	0,055555556
v36 Cell 1 voltage (mV). +ve = OK, -ve = channel mismatch	0	0,055555556	0,055555556	0,055555556

Figure C.9: VRI values for Primavera2 Vehicle - World Solar Challenge 2015

v37	Cell 2 voltage (mV). +ve = OK, -ve = channel mismatch	0	0,055555556	0,055555556	0,055555556
v38	Cell 3 voltage (mV). +ve = OK, -ve = channel mismatch	0	0,055555556	0,055555556	0,055555556
v39	Cell 4 voltage (mV). +ve = OK, -ve = channel mismatch	0	0,055555556	0,055555556	0,055555556
v40	Cell 5 voltage (mV). +ve = OK, -ve = channel mismatch	0	0,055555556	0,055555556	0,055555556
v41	Cell 6 voltage (mV). +ve = OK, -ve = channel mismatch	0	0,055555556	0,055555556	0,055555556
v42	Cell 7 voltage (mV). +ve = OK, -ve = channel mismatch	0	0,055555556	0,055555556	0,055555556
v43	Cell 0 voltage (mV). +ve = OK, -ve = channel mismatch	0	0,055555556	0,055555556	0,055555556
v44	Cell 1 voltage (mV). +ve = OK, -ve = channel mismatch	0	0,055555556	0,055555556	0,055555556
v45	Cell 2 voltage (mV). +ve = OK, -ve = channel mismatch	0	0,055555556	0,055555556	0,055555556
v46	Cell 3 voltage (mV). +ve = OK, -ve = channel mismatch	0	0,055555556	0,055555556	0,055555556
v47	Cell 4 voltage (mV). +ve = OK, -ve = channel mismatch	0	0,055555556	0,055555556	0,055555556
v48	Cell 5 voltage (mV). +ve = OK, -ve = channel mismatch	0	0,055555556	0,055555556	0,055555556
v49	Cell 6 voltage (mV). +ve = OK, -ve = channel mismatch	0	0,055555556	0,055555556	0,055555556
v50	Cell 7 voltage (mV). +ve = OK, -ve = channel mismatch	0	0,055555556	0,055555556	0,055555556
v51	Cell 0 voltage (mV). +ve = OK, -ve = channel mismatch	0	0,055555556	0,055555556	0,055555556
v52	Cell 1 voltage (mV). +ve = OK, -ve = channel mismatch	0	0,055555556	0,055555556	0,055555556
v53	Cell 2 voltage (mV). +ve = OK, -ve = channel mismatch	0	0,055555556	0,055555556	0,055555556
v54	Cell 3 voltage (mV). +ve = OK, -ve = channel mismatch	0	0,055555556	0,055555556	0,055555556
v55	Cell 4 voltage (mV). +ve = OK, -ve = channel mismatch	0	0,055555556	0,055555556	0,055555556
v56	Cell 5 voltage (mV). +ve = OK, -ve = channel mismatch	0	0,055555556	0,055555556	0,055555556
v57	Cell 6 voltage (mV). +ve = OK, -ve = channel mismatch	0	0,055555556	0,055555556	0,055555556
v58	Cell 7 voltage (mV). +ve = OK, -ve = channel mismatch	0	0,055555556	0,055555556	0,055555556
v59	Cell 0 voltage (mV). +ve = OK, -ve = channel mismatch	0	0,055555556	0,055555556	0,055555556
v60	Cell 1 voltage (mV). +ve = OK, -ve = channel mismatch	0	0,055555556	0,055555556	0,055555556
v61	Cell 2 voltage (mV). +ve = OK, -ve = channel mismatch	0	0,055555556	0,055555556	0,055555556
v62	Cell 3 voltage (mV). +ve = OK, -ve = channel mismatch	0	0,055555556	0,055555556	0,055555556
v63	Cell 4 voltage (mV). +ve = OK, -ve = channel mismatch	0	0,055555556	0,055555556	0,055555556
v64	Cell 5 voltage (mV). +ve = OK, -ve = channel mismatch	0	0,055555556	0,055555556	0,055555556
v65	Cell 6 voltage (mV). +ve = OK, -ve = channel mismatch	0	0,055555556	0,055555556	0,055555556
v66	Cell 7 voltage (mV). +ve = OK, -ve = channel mismatch	0	0,055555556	0,055555556	0,055555556
v67	Cell 0 voltage (mV). +ve = OK, -ve = channel mismatch	0	0,055555556	0,055555556	0,055555556

Figure C.10: VRI values for *Primavera2* Vehicle - World Solar Challenge 2015 (Continuation)

v68	Cell 1 voltage (mV). +ve = OK, -ve = channel mismatch	0	0,055555556	0,055555556	0,055555556
v69	Cell 2 voltage (mV). +ve = OK, -ve = channel mismatch	0	0,055555556	0,055555556	0,055555556
v70	Cell 3 voltage (mV). +ve = OK, -ve = channel mismatch	0	0,055555556	0,055555556	0,055555556
v71	Cell 4 voltage (mV). +ve = OK, -ve = channel mismatch	0	0,055555556	0,055555556	0,055555556
v72	Cell 5 voltage (mV). +ve = OK, -ve = channel mismatch	0	0,055555556	0,055555556	0,055555556
v73	Cell 6 voltage (mV). +ve = OK, -ve = channel mismatch	0	0,055555556	0,055555556	0,055555556
v74	Cell 7 voltage (mV). +ve = OK, -ve = channel mismatch	0	0,055555556	0,055555556	0,055555556
v75	Shows the balancing SOC as a percentage, in other words, the percentage mismatch between cells this session.	0	0,055555556	0,055555556	0,055555556
v76	Discharging cell voltage error (mV)	0	0,055555556	0,055555556	0,055555556
v77	Minimum / Maximum cell temperature	0	0,055555556	0,055555556	0,055555556
v78	CMU number that has the minimum cell temperature	0	0,055555556	0,055555556	0,055555556
v79	CMU number that has the maximum cell temperature	0	0,055555556	0,055555556	0,055555556
v80	Bus Current - Desired set point of current drawn from the bus by the controller as a percentage of absolute bus current limit.	0	0,055555556	0,055555556	0,055555556
v81	DC Bus AmpHours - Charge flow into the controller DC bus from the time of reset.	0	0,055555556	0,055555556	0,055555556
v82	Temperature (°C)	0	0,055555556	0,055555556	0,055555556
v83	Extended battery pack status	0	0,050925926	0,050925926	0
v84	Motor Current -Desired motor current set point as a percentage of maximum current setting.	0	0,041666667	0,041666667	0
v85	Receive error count	0	0,041666667	0,041666667	0,041666667
v86	Transmit error count	0	0,041666667	0,041666667	0,041666667
v87	Minimum / Maximum cell voltage	0	0,027777778	0,027777778	0
v88	Temp(Temperature of MPPT +5°C)	0	0	0,027777778	0,027777778
v89	PCB temperature ( 1/10th °C)	0	0,018518519	0,018518519	0,018518519
v90	Cell temperature ( 1/10th °C)	0	0,018518519	0,018518519	0,018518519
v91	PCB temperature ( 1/10th °C)	0	0,018518519	0,018518519	0,018518519
v92	Cell temperature ( 1/10th °C)	0	0,018518519	0,018518519	0,018518519
v93	PCB temperature ( 1/10th °C)	0	0,018518519	0,018518519	0,018518519
v94	Cell temperature ( 1/10th °C)	0	0,018518519	0,018518519	0,018518519
v95	PCB temperature ( 1/10th °C)	0	0,018518519	0,018518519	0,018518519
v96	Cell temperature ( 1/10th °C)	0	0,018518519	0,018518519	0,018518519
v97	PCB temperature ( 1/10th °C)	0	0,018518519	0,018518519	0,018518519
v98	Cell temperature ( 1/10th °C)	0	0,018518519	0,018518519	0,018518519
v99	Cell temperature margin ( 1 /10th °C)	0	0,018518519	0,018518519	0,018518519
v100	CMU number that has the minimum cell voltage	0	0,018518519	0,018518519	0,018518519
v101	CMU number that has the maximum cell voltage	0	0,018518519	0,018518519	0,018518519
v102	12V current consumption of fans + contactors (mA)	0	0,018518519	0,018518519	0,018518519
v103	12V current consumption of CMUs (mA)	0	0,018518519	0,018518519	0,018518519
v104	Precharge status, 12V status	0	0,009259259	0,009259259	0
v105	12V contactor supply voltage, mV (only on v4 or earlier BMU) for v5 or later BMU, refer to binary bit 0x10 in data_u8[0]	0	0,009259259	0,009259259	0
v106	IPM Heat-sink Temp - Internal temperature of Heat-sink in main IPM	0	0,009259259	0,009259259	0

Figure C.11: VRI values for Primavera2 Vehicle - World Solar Challenge 2015 (Continuation)

---

v107 Motor Temp - Internal temperature of the motor.	0	0,009259259	0,009259259	0
v108 Slip Speed - Slip speed when driving an induction motor	0	0,009259259	0,009259259	0
v109 BMU heartbeat & serial number	0	0	0	0

Figure C.12: VRI values for *Primavera2* Vehicle - World Solar Challenge 2015 (Continuation)



## **Appendix D**

### **Specific Power Consumption SPC**

**Graphic for *Primavera 2* for Bridgestone**

**World Solar Challenge 2017**

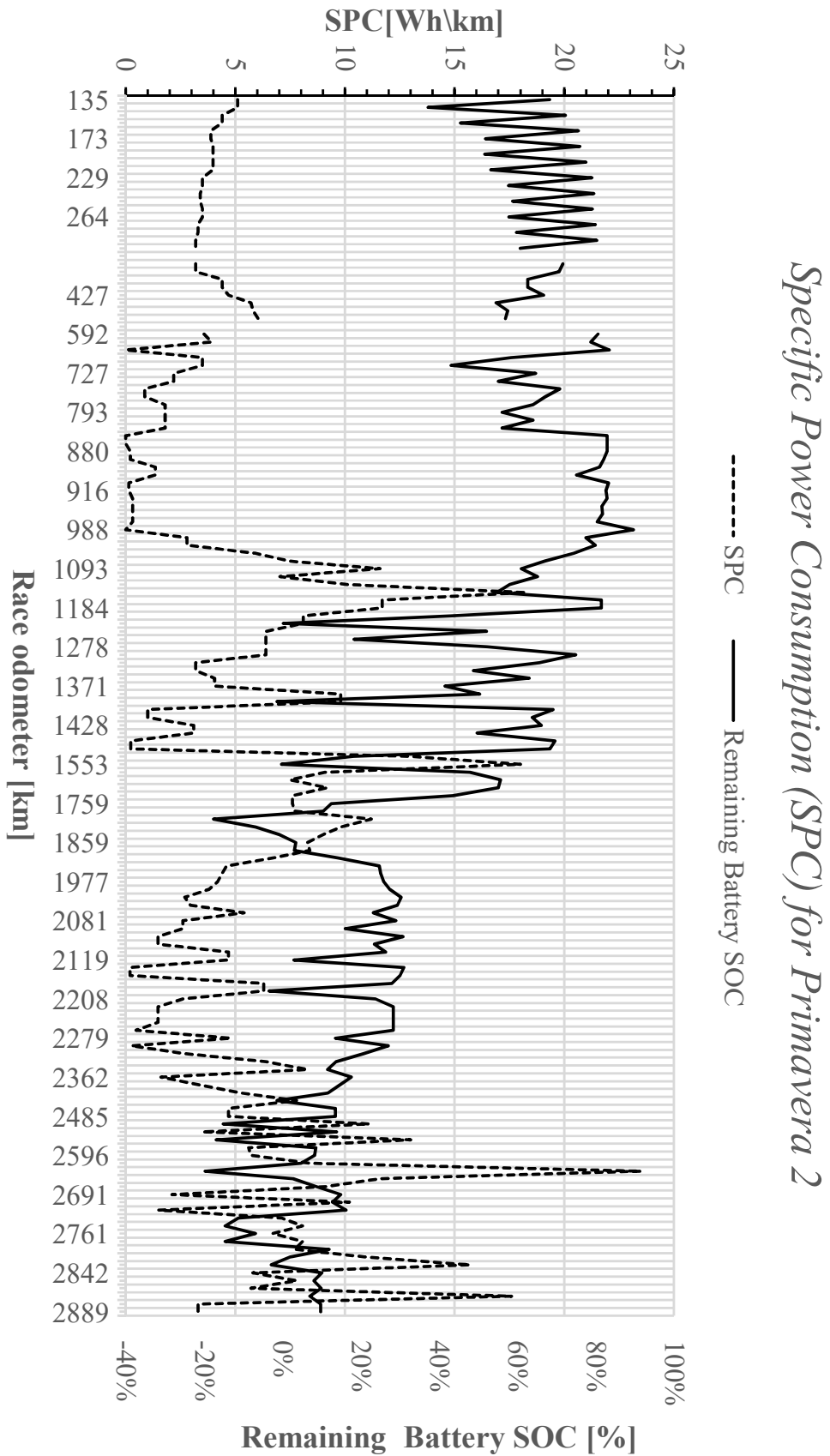

Figure D.1: Specific Power Consumption (SPC). added variable during Primavera 2 race in Australia.